



**INVERTER
ARC
WELDER**

MODEL 300GT SW AC/DC CC/TIG

- **STICK**
- **TIG - HIGH FREQUENCY
- LIFT START**

OPERATING MANUAL

TABLE OF CONTENTS

1.0 GENERAL INFORMATION	2
1.01 Notes, Cautions and Warnings	2
1.02 Important Safety Precautions	3
1.03 Publications	6
1.04 Note, Attention et Avertissement	7
1.05 Precautions De Securite Importantes	8
1.06 Documents De Reference	11
1.07 Declaration of Conformity	12
1.08 Statement of Warranty	13
2.0 INTRODUCTION AND DESCRIPTION	15
2.01 Description	15
2.02 Functional Block Diagram	16
2.03 Transporting Methods	17
2.04 Electrical Input Connections	17
2.05 Specifications	19
2.06 Duty Cycle	20
3.0 OPERATOR CONTROLS	21
3.01 Front and Rear panel operator controls	21
3.02 Setup for Operation	23
Shielded Metal Arc Welding (SMAW)	24
Gas Tungsten Arc Welding (GTAW) High Frequency/Lift Start	26
(Gas Tungsten Arc Welding-Pulsed (GTAW-P) -Sloped (GTAW-S) -TIG Spot	28
4.0 BASIC TROUBLESHOOTING	31
4.01 Common Welding Operation Faults	31
4.02 Specific Problems	31
4.03 REMOTE 8-Pin Connections	36
APPENDIX A – ACCESSORIES	38
APPENDIX B – INTERCONNECTION DIAGRAMS	41

**WARNING**

Read and understand this entire Operating Manual and your employer's safety practices before installing, operating, or servicing the equipment.

**WARNING**

While the information contained in this Operating Manual represents our best judgement, Thermal Dynamics Corporation assumes no liability for its use.

Thermal Arc Models 300GTSW AC/DC CC/TIG Welder
Operating Manual Number 0-2514

Published by:
Thermal Dynamics Corporation
Industrial Park No. 2
West Lebanon, New Hampshire, USA 03784
(603) 298-5711

Copyright 1997 by
Thermal Dynamics Corporation

All rights reserved.

Reproduction of this work, in whole or in part, without written permission of the publisher is prohibited.

The publisher does not assume and hereby disclaims any liability to any party for any loss or damage caused by any error or omission in this Operating Manual, whether such error results from negligence, accident, or any other cause.

Printed in the United States of America

July 1, 1997

1.0 GENERAL INFORMATION

1.01 NOTES, CAUTIONS AND WARNINGS

Throughout this manual, notes, cautions, and warnings are used to highlight important information. These highlights are categorized as follows:

NOTE

An operation, procedure, or background information which requires additional emphasis or is helpful in efficient operation of the system.

CAUTION

A procedure which, if not properly followed, may cause damage to the equipment.



WARNING

A procedure which, if not properly followed, may cause injury to the operator or others in the operating area.



WARNING

1.02 IMPORTANT SAFETY PRECAUTIONS

OPERATION AND MAINTENANCE OF PLASMA ARC EQUIPMENT CAN BE DANGEROUS AND HAZARDOUS TO YOUR HEALTH.

To prevent possible injury, read, understand and follow all warnings, safety precautions and instructions before using the equipment. Call 1-603-298-5711 or your local distributor if you have any questions.

GASES AND FUMES



Gases and fumes produced during the plasma cutting process can be dangerous and hazardous to your health.

- Keep all fumes and gases from the breathing area. Keep your head out of the welding fume plume.
- Use an air-supplied respirator if ventilation is not adequate to remove all fumes and gases.
- The kinds of fumes and gases from the plasma arc depend on the kind of metal being used, coatings on the metal, and the different processes. You must be very careful when cutting or welding any metals which may contain one or more of the following:

Antimony	Chromium	Mercury
Arsenic	Cobalt	Nickel
Barium	Copper	Selenium
Beryllium	Lead	Silver
Cadmium	Manganese	Vanadium

- Always read the Material Safety Data Sheets (MSDS) that should be supplied with the material you are using. These MSDSs will give you the information regarding the kind and amount of fumes and gases that may be dangerous to your health.
- For information on how to test for fumes and gases in your workplace, refer to item 1 in the Publications Section in this manual.
- Use special equipment, such as water or down draft cutting tables, to capture fumes and gases.
- Do not use the plasma torch in an area where combustible or explosive gases or materials are located.
- Phosgene, a toxic gas, is generated from the vapors of chlorinated solvents and cleansers. Remove all sources of these vapors.

IMPORTANT SAFETY PRECAUTIONS (CONTINUED)

ELECTRIC SHOCK



Electric Shock can injure or kill. The plasma arc process uses and produces high voltage electrical energy. This electric energy can cause severe or fatal shock to the operator or others in the workplace.

- Never touch any parts that are electrically “live” or “hot.”
- Wear dry gloves and clothing. Insulate yourself from the work piece or other parts of the welding circuit.
- Repair or replace all worn or damaged parts.
- Extra care must be taken when the workplace is moist or damp.
- Install and maintain equipment according to NEC code, refer to item 4 in the Publications section of this manual.
- Disconnect power source before performing any service or repairs.
- Read and follow all the instructions in the Operating Manual.

FIRE AND EXPLOSION



Fire and explosion can be caused by hot slag, sparks, or the plasma arc.

- Be sure there is no combustible or flammable material in the workplace. Any material that cannot be removed must be protected.
- Ventilate all flammable or explosive vapors from the workplace.
- Do not cut or weld on containers that may have held combustibles.
- Provide a fire watch when working in an area where fire hazards may exist.
- Hydrogen gas may be formed and trapped under aluminum workpieces when they are cut underwater or while using a water table. **DO NOT** cut aluminum alloys underwater or on a water table unless the hydrogen gas can be eliminated or dissipated. Trapped hydrogen gas that is ignited will cause an explosion.

NOISE



Noise can cause permanent hearing loss. Plasma arc processes can cause noise levels to exceed safe limits. You must protect your ears from loud noise to prevent permanent loss of hearing.

- To protect your hearing from loud noise, wear protective ear plugs and/or ear muffs. Protect others in the workplace.
- Noise levels should be measured to be sure the decibels (sound) do not exceed safe levels.
- For information on how to test for noise, see item 1 in the Publications section of this manual.

IMPORTANT SAFETY PRECAUTIONS (CONTINUED)

PLASMA ARC RAYS



Plasma Arc Rays can injure your eyes and burn your skin. The plasma arc process produces very bright ultra violet and infra red light. These arc rays will damage your eyes and burn your skin if you are not properly protected.

- To protect your eyes, always wear a welding helmet or shield. Also always wear safety glasses with side shields, goggles or other protective eye wear.
- Wear welding gloves and suitable clothing to protect your skin from the arc rays and sparks.
- Keep helmet and safety glasses in good condition. Replace lenses when cracked, chipped or dirty.
- Protect others in the work area from the arc rays. Use protective booths, screens or shields.
- Use the shade of lens as recommended in the Operating Manual.

1.03 PUBLICATIONS

Refer to the following standards or their latest revisions for more information:

1. OSHA, SAFETY AND HEALTH STANDARDS, 29CFR 1910, obtainable from the Superintendent of Documents, U.S. Government Printing Office, Washington, D.C. 20402
2. ANSI Standard Z49.1, SAFETY IN WELDING AND CUTTING, obtainable from the American Welding Society, 550 N.W. LeJeune Rd, Miami, FL 33126
3. NIOSH, SAFETY AND HEALTH IN ARC WELDING AND GAS WELDING AND CUTTING, obtainable from the Superintendent of Documents, U.S. Government Printing Office, Washington, D.C. 20402
4. ANSI Standard Z87.1, SAFE PRACTICES FOR OCCUPATION AND EDUCATIONAL EYE AND FACE PROTECTION, obtainable from American National Standards Institute, 1430 Broadway, New York, NY 10018
5. ANSI Standard Z41.1, STANDARD FOR MEN'S SAFETY-TOE FOOTWEAR, obtainable from the American National Standards Institute, 1430 Broadway, New York, NY 10018
6. ANSI Standard Z49.2, FIRE PREVENTION IN THE USE OF CUTTING AND WELDING PROCESSES, obtainable from American National Standards Institute, 1430 Broadway, New York, NY 10018
7. AWS Standard A6.0, WELDING AND CUTTING CONTAINERS WHICH HAVE HELD COMBUSTIBLES, obtainable from American Welding Society, 550 N.W. LeJeune Rd, Miami, FL 33126
8. NFPA Standard 51, OXYGEN-FUEL GAS SYSTEMS FOR WELDING, CUTTING AND ALLIED PROCESSES, obtainable from the National Fire Protection Association, Batterymarch Park, Quincy, MA 02269
9. NFPA Standard 70, NATIONAL ELECTRICAL CODE, obtainable from the National Fire Protection Association, Batterymarch Park, Quincy, MA 02269
10. NFPA Standard 51B, CUTTING AND WELDING PROCESSES, obtainable from the National Fire Protection Association, Batterymarch Park, Quincy, MA 02269
11. CGA Pamphlet P-1, SAFE HANDLING OF COMPRESSED GASES IN CYLINDERS, obtainable from the Compressed Gas Association, 1235 Jefferson Davis Highway, Suite 501, Arlington, VA 22202
12. CSA Standard W117.2, CODE FOR SAFETY IN WELDING AND CUTTING, obtainable from the Canadian Standards Association, Standards Sales, 178 Rexdale Boulevard, Rexdale, Ontario, Canada M9W 1R3
13. NWSA booklet, WELDING SAFETY BIBLIOGRAPHY obtainable from the National Welding Supply Association, 1900 Arch Street, Philadelphia, PA 19103
14. American Welding Society Standard AWSF4.1, RECOMMENDED SAFE PRACTICES FOR THE PREPARATION FOR WELDING AND CUTTING OF CONTAINERS AND PIPING THAT HAVE HELD HAZARDOUS SUBSTANCES, obtainable from the American Welding Society, 550 N.W. LeJeune Rd, Miami, FL 33126
15. ANSI Standard Z88.2, PRACTICE FOR RESPIRATORY PROTECTION, obtainable from American National Standards Institute, 1430 Broadway, New York, NY 10018

1.04 NOTE, ATTENTION ET AVERTISSEMENT

Dans ce manuel, les mots “note,” “attention,” et “avertissement” sont utilisés pour mettre en relief des informations à caractère important. Ces mises en relief sont classifiées comme suit :

NOTE

Toute opération, procédure ou renseignement général sur lequel il importe d’insister davantage ou qui contribue à l’efficacité de fonctionnement du système.

ATTENTION

Toute procédure pouvant résulter l’endommagement du matériel en cas de non-respect de la procédure en question.

AVERTISSEMENT



Toute procédure pouvant provoquer des blessures de l’opérateur ou des autres personnes se trouvant dans la zone de travail en cas de non-respect de la procédure en question.



AVERTISSEMENT

1.05 PRECAUTIONS DE SECURITE IMPORTANTES

L'OPÉRATION ET LA MAINTENANCE DU MATÉRIEL DE SOUDAGE À L'ARC AU JET DE PLASMA PEUVENT PRÉSENTER DES RISQUES ET DES DANGERS DE SANTÉ.

Il faut communiquer aux opérateurs et au personnel TOUS les dangers possibles. Afin d'éviter les blessures possibles, lisez, comprenez et suivez tous les avertissements, toutes les précautions de sécurité et toutes les consignes avant d'utiliser le matériel. Composez le + 603-298-5711 ou votre distributeur local si vous avez des questions.

FUMÉE et GAZ



La fumée et les gaz produits par le procédé de jet de plasma peuvent présenter des risques et des dangers de santé.

- Eloignez toute fumée et gaz de votre zone de respiration. Gardez votre tête hors de la plume de fumée provenant du chalumeau.
- Utilisez un appareil respiratoire à alimentation en air si l'aération fournie ne permet pas d'éliminer la fumée et les gaz.
- Les sortes de gaz et de fumée provenant de l'arc de plasma dépendent du genre de métal utilisé, des revêtements se trouvant sur le métal et des différents procédés. Vous devez prendre soin lorsque vous coupez ou soudez tout métal pouvant contenir un ou plusieurs des éléments suivants:

antimoine	cadmium	mercure
argent	chrome	nickel
arsenic	cobalt	plomb
baryum	cuiivre	sélénium
béryllium	manganèse	vanadium

- Lisez toujours les fiches de données sur la sécurité des matières (sigle américain "MSDS"); celles-ci devraient être fournies avec le matériel que vous utilisez. Les MSDS contiennent des renseignements quant à la quantité et la nature de la fumée et des gaz pouvant poser des dangers de santé.
- Pour des informations sur la manière de tester la fumée et les gaz de votre lieu de travail, consultez l'article 1 et les documents cités à la page 11.
- Utilisez un équipement spécial tel que des tables de coupe à débit d'eau ou à courant descendant pour capter la fumée et les gaz.
- N'utilisez pas le chalumeau au jet de plasma dans une zone où se trouvent des matières ou des gaz combustibles ou explosifs.
- Le phosgène, un gaz toxique, est généré par la fumée provenant des solvants et des produits de nettoyage chlorés. Éliminez toute source de telle fumée.

PRECAUTIONS DE SECURITE IMPORTANTES

CHOC ELECTRIQUE



Les chocs électriques peuvent blesser ou même tuer. Le procédé au jet de plasma requiert et produit de l'énergie électrique haute tension. Cette énergie électrique peut produire des chocs graves, voire mortels, pour l'opérateur et les autres personnes sur le lieu de travail.

- Ne touchez jamais une pièce "sous tension" ou "vive"; portez des gants et des vêtements secs. Isolez-vous de la pièce de travail ou des autres parties du circuit de soudage.
- Réparez ou remplacez toute pièce usée ou endommagée.
- Prenez des soins particuliers lorsque la zone de travail est humide ou moite.
- Montez et maintenez le matériel conformément au Code électrique national des Etats-Unis. (Voir la page 6, article 9.)
- Débranchez l'alimentation électrique avant tout travail d'entretien ou de réparation.
- Lisez et respectez toutes les consignes du Manuel de consignes.

INCENDIE ET EXPLOSION



Les incendies et les explosions peuvent résulter des scories chaudes, des étincelles ou de l'arc de plasma. Le procédé à l'arc de plasma produit du métal, des étincelles, des scories chaudes pouvant mettre le feu aux matières combustibles ou provoquer l'explosion de fumées inflammables.

- Soyez certain qu'aucune matière combustible ou inflammable ne se trouve sur le lieu de travail. Protégez toute telle matière qu'il est impossible de retirer de la zone de travail.
- Procurez une bonne aération de toutes les fumées inflammables ou explosives.
- Ne coupez pas et ne soudez pas les conteneurs ayant pu renfermer des matières combustibles.
- Prévoyez une veille d'incendie lors de tout travail dans une zone présentant des dangers d'incendie.
- Le gas hydrogène peut se former ou s'accumuler sous les pièces de travail en aluminium lorsqu'elles sont coupées sous l'eau ou sur une table d'eau. NE PAS couper les alliages en aluminium sous l'eau ou sur une table d'eau à moins que le gas hydrogène peut s'échapper ou se dissiper. Le gas hydrogène accumulé explosera si enflammé.

PRECAUTIONS DE SECURITE IMPORTANTES

RAYONS D'ARC DE PLASMA



Les rayons provenant de l'arc de plasma peuvent blesser vos yeux et brûler votre peau. Le procédé à l'arc de plasma produit une lumière infra-rouge et des rayons ultra-violetes très forts. Ces rayons d'arc nuiront à vos yeux et brûleront votre peau si vous ne vous protégez pas correctement.

- Pour protéger vos yeux, portez toujours un casque ou un écran de soudeur. Portez toujours des lunettes de sécurité munies de parois latérales ou des lunettes de protection ou une autre sorte de protection oculaire.



- Portez des gants de soudeur et un vêtement protecteur approprié pour protéger votre peau contre les étincelles et les rayons de l'arc.

- Maintenez votre casque et vos lunettes de protection en bon état. Remplacez toute lentille sale ou comportant fissure ou rognure.

- Protégez les autres personnes se trouvant sur la zone de travail contre les rayons de l'arc en fournissant des cabines ou des écrans de protection.

- Respectez le teint de lentille recommandé dans le manuel de consignes.

BRUIT

Le bruit peut provoquer une perte permanente de l'ouïe. Les procédés de soudage à l'arc de plasma peuvent provoquer des niveaux sonores supérieurs aux limites normalement acceptables. Vous devez vous protéger les oreilles contre les bruits forts afin d'éviter une perte permanente de l'ouïe.

- Pour protéger votre ouïe contre les bruits forts, portez des tampons protecteurs et/ou des protections auriculaires. Protégez également les autres personnes se trouvant sur le lieu de travail.

- Il faut mesurer les niveaux sonores afin d'assurer que les décibels (le bruit) ne dépassent pas les niveaux sûrs.

- Pour des renseignements sur la manière de tester le bruit, consultez l'article 1, page 11.

1.06 DOCUMENTS DE REFERENCE

Consultez les normes suivantes ou les révisions les plus récentes ayant été faites à celles-ci pour de plus amples renseignements :

1. OSHA, NORMES DE SÉCURITÉ DU TRAVAIL ET DE PROTECTION DE LA SANTÉ, 29CFR 1910, disponible auprès du Superintendent of Documents, U.S. Government Printing Office, Washington, D.C. 20402
2. Norme ANSI Z49.1, LA SÉCURITÉ DES OPÉRATIONS DE COUPE ET DE SOUDAGE, disponible auprès de la Société Américaine de Soudage (American Welding Society), 550 N.W. LeJeune Rd., Miami, FL 33126
3. NIOSH, LA SÉCURITÉ ET LA SANTÉ LORS DES OPÉRATIONS DE COUPE ET DE SOUDAGE À L'ARC ET AU GAZ, disponible auprès du Superintendent of Documents, U.S. Government Printing Office, Washington, D.C. 20402
4. Norme ANSI Z87.1, PRATIQUES SURES POUR LA PROTECTION DES YEUX ET DU VISAGE AU TRAVAIL ET DANS LES ECOLES, disponible de l'Institut Américain des Normes Nationales (American National Standards Institute), 1430 Broadway, New York, NY 10018
5. Norme ANSI Z41.1, NORMES POUR LES CHAUSSURES PROTECTRICES, disponible auprès de l'American National Standards Institute, 1430 Broadway, New York, NY 10018
6. Norme ANSI Z49.2, PRÉVENTION DES INCENDIES LORS DE L'EMPLOI DE PROCÉDÉS DE COUPE ET DE SOUDAGE, disponible auprès de l'American National Standards Institute, 1430 Broadway, New York, NY 10018
7. Norme A6.0 de l'Association Américaine du Soudage (AWS), LE SOUDAGE ET LA COUPE DE CONTENEURS AYANT RENFERMÉ DES PRODUITS COMBUSTIBLES, disponible auprès de la American Welding Society, 550 N.W. LeJeune Rd., Miami, FL 33126
8. Norme 51 de l'Association Américaine pour la Protection contre les Incendies (NFPA), LES SYSTEMES À GAZ AVEC ALIMENTATION EN OXYGENE POUR LE SOUDAGE, LA COUPE ET LES PROCÉDÉS ASSOCIÉS, disponible auprès de la National Fire Protection Association, Batterymarch Park, Quincy, MA 02269
9. Norme 70 de la NFPA, CODE ELECTRIQUE NATIONAL, disponible auprès de la National Fire Protection Association, Batterymarch Park, Quincy, MA 02269
10. Norme 51B de la NFPA, LES PROCÉDÉS DE COUPE ET DE SOUDAGE, disponible auprès de la National Fire Protection Association, Batterymarch Park, Quincy, MA 02269
11. Brochure GCA P-1, LA MANIPULATION SANS RISQUE DES GAZ COMPRIMÉS EN CYLINDRES, disponible auprès de l'Association des Gaz Comprimés (Compressed Gas Association), 1235 Jefferson Davis Highway, Suite 501, Arlington, VA 22202
12. Norme CSA W117.2, CODE DE SÉCURITÉ POUR LE SOUDAGE ET LA COUPE, disponible auprès de l'Association des Normes Canadiennes, Standards Sales, 178 Rexdale Boulevard, Rexdale, Ontario, Canada, M9W 1R3
13. ivret NWSA, BIBLIOGRAPHIE SUR LA SÉCURITÉ DU SOUDAGE, disponible auprès de l'Association Nationale de Fournitures de Soudage (National Welding Supply Association), 1900 Arch Street, Philadelphia, PA 19103
14. Norme AWSF4.1 de l'Association Américaine de Soudage, RECOMMANDATIONS DE PRATIQUES SURES POUR LA PRÉPARATION À LA COUPE ET AU SOUDAGE DE CONTENEURS ET TUYAUX AYANT RENFERMÉ DES PRODUITS DANGEREUX , disponible auprès de la American Welding Society, 550 N.W. LeJeune Rd., Miami, FL 33126
15. Norme ANSI Z88.2, PRATIQUES DE PROTECTION RESPIRATOIRE, disponible auprès de l'American National Standards Institute, 1430 Broadway, New York, NY 10018

1.07 DECLARATION OF CONFORMITY

Manufacturer: Thermal Dynamics Corporation
Address: Industrial Park #2
West Lebanon, New Hampshire 03784
USA

The equipment described in this manual conforms to all applicable aspects and regulations of the 'Low Voltage Directive' (European Council Directive 73/23/EU, as recently changed in Directive 93/63/EU) and to the National legislation for the enforcement of this Directive.

The equipment described in this manual conforms to all applicable aspects and regulations of the "EMC Directive" (European Council Directive 89/336/EEC) and to the National legislation for the enforcement of this Directive.

Serial numbers are unique with each individual piece of equipment and details description, parts used to manufacture a unit and date of manufacture.

National Standard and Technical Specifications

The product is designed and manufactured to a number of standards and technical requirements among them are:

- * CSA (Canadian Standards Association) standard C22.2 number 60-M1990 for Arc welding equipment.
- * UL (Underwriters Laboratory) rating 94VO flammability testing for all printed-circuit boards used.
- * CENELEC EN50199 EMC Product Standard for Arc Welding Equipment March 1995.
- * IEC 974-1 (BS 638-PT10) (EN 60 974-1) applicable to welding equipment and associated accessories.
- * Extensive product design verification is conducted at the manufacturing facility as part of the routine design and manufacturing process, to ensure the product is safe and performs as specified. Rigorous testing is incorporated into the manufacturing process to ensure the manufactured product meets or exceeds all design specifications.

Thermal Dynamics has been manufacturing products that perform in a safe manner for more than 30 years and will continue to achieve excellence in our area of manufacture.

Manufacturers responsible representative: David Ashworth
Vice President & Managing Director
Thermadyne Europe
Chorley England.

1.08 STATEMENT OF WARRANTY

LIMITED WARRANTY: Thermal Dynamics Corporation (hereinafter "Thermal") warrants that its products will be free of defects in workmanship or material. Should any failure to conform to this warranty appear within the time period applicable to the Thermal products as stated below, Thermal shall, upon notification thereof and substantiation that the product has been stored, installed, operated, and maintained in accordance with Thermal's specifications, instructions, recommendations and recognized standard industry practice, and not subject to misuse, repair, neglect, alteration, or accident, correct such defects by suitable repair or replacement, at Thermal's sole option, of any components or parts of the product determined by Thermal to be defective.

THIS WARRANTY IS EXCLUSIVE AND IS IN LIEU OF ANY WARRANTY OF MERCHANTABILITY OR FITNESS FOR A PARTICULAR PURPOSE.

LIMITATION OF LIABILITY: Thermal shall not under any circumstances be liable for special or consequential damages, such as, but not limited to, damage or loss of purchased or replacement goods, or claims of customers of distributor (hereinafter "Purchaser") for service interruption. The remedies of the Purchaser set forth herein are exclusive and the liability of Thermal with respect to any contract, or anything done in connection therewith such as the performance or breach thereof, or from the manufacture, sale, delivery, resale, or use of any goods covered by or furnished by Thermal whether arising out of contract, negligence, strict tort, or under any warranty, or otherwise, shall not, except as expressly provided herein, exceed the price of the goods upon which such liability is based.

THIS WARRANTY BECOMES INVALID IF REPLACEMENT PARTS OR ACCESSORIES ARE USED WHICH MAY IMPAIR THE SAFETY OR PERFORMANCE OF ANY THERMAL PRODUCT.

THIS WARRANTY IS INVALID IF THE PRODUCT IS SOLD BY NON-AUTHORIZED PERSONS.

The limited warranty periods for Thermal products shall be as follows: A maximum of three (3) years from date of sale to an authorized distributor and a maximum of two (2) years from date of sale by such distributor to the Purchaser, and with the following further limitations on such two (2) year period:

<u>PAK UNITS, POWER SUPPLIES</u>	<u>PARTS</u>	<u>LABOR</u>
MAIN POWER MAGNETICS	2 YEARS	1 YEAR
ORIGINAL MAIN POWER RECTIFIER	2 YEARS	1 YEAR
CONTROL PC BOARD	2 YEARS	1 YEAR
ALL OTHER CIRCUITS AND COMPONENTS	1 YEAR	1 YEAR
INCLUDING, BUT NOT LIMITED TO, STARTING CIRCUIT, CONTACTORS, RELAYS, SOLENOIDS, PUMPS, POWER SWITCHING SEMI-CONDUCTORS		
<u>CONSOLES, CONTROL EQUIPMENT, HEAT</u>	1 YEAR	1 YEAR
<u>EXCHANGES, AND ACCESSORY EQUIPMENT</u>		
<u>TORCH AND LEADS</u>	180 DAYS	180 DAYS
<u>REPAIR/REPLACEMENT PARTS</u>	90 DAYS	90 DAYS

Warranty repairs or replacement claims under this limited warranty must be submitted by an authorized Thermal Arc® repair facility within thirty (30) days of the repair. Authorized Thermal Arc® repair facilities are authorized distributors and authorized Thermal Arc® Service Centers. No transportation costs of any kind will be paid under this warranty. Transportation charges to send products to an authorized warranty repair facility shall be the responsibility of the customer. All returned goods shall be at the customer's risk and expense. This warranty supersedes all previous Thermal warranties.

Thermal Arc® is a Registered Trademark of Thermal Dynamics.

Effective January 18, 1991

2.0 INTRODUCTION AND DESCRIPTION

2.01 Description

The Thermal Arc™ Model 300GTSW is a three-phase or single-phase (if derated) AC/DC arc welding power source with Constant Current (CC) output characteristics. The unit is equipped with a gas control valve, built-in Sloper and Pulser, lift arc starter, and high-frequency arc starter for use with Gas Tungsten Arc Welding (GTAW), Gas Tungsten Arc Welding-Pulsed (GTAW-P), Gas Tungsten Arc Welding-Sloped (GTAW-S), and Shielded Metal Arc Welding (SMAW) processes.

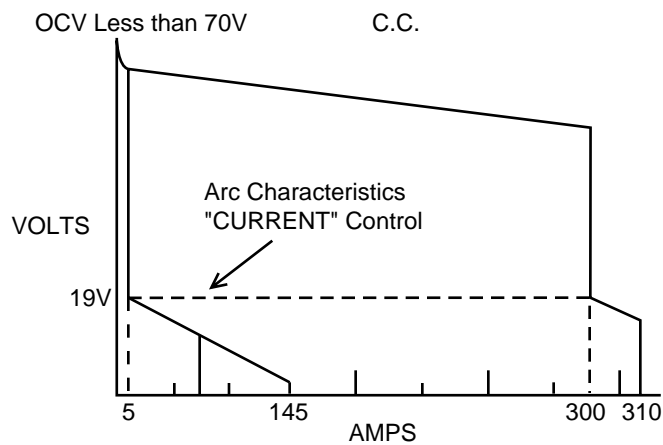

Figure 1. Model 300GTSW Volt-Ampere curve

NOTE

Volt-Ampere curves show the maximum Voltage and Amperage output capabilities of the welding power source. Curves of other settings will fall between the curves shown.

2.02 Functional Block Diagram

Figure 2 illustrates the functional block diagram of the 300GTSW power supply.

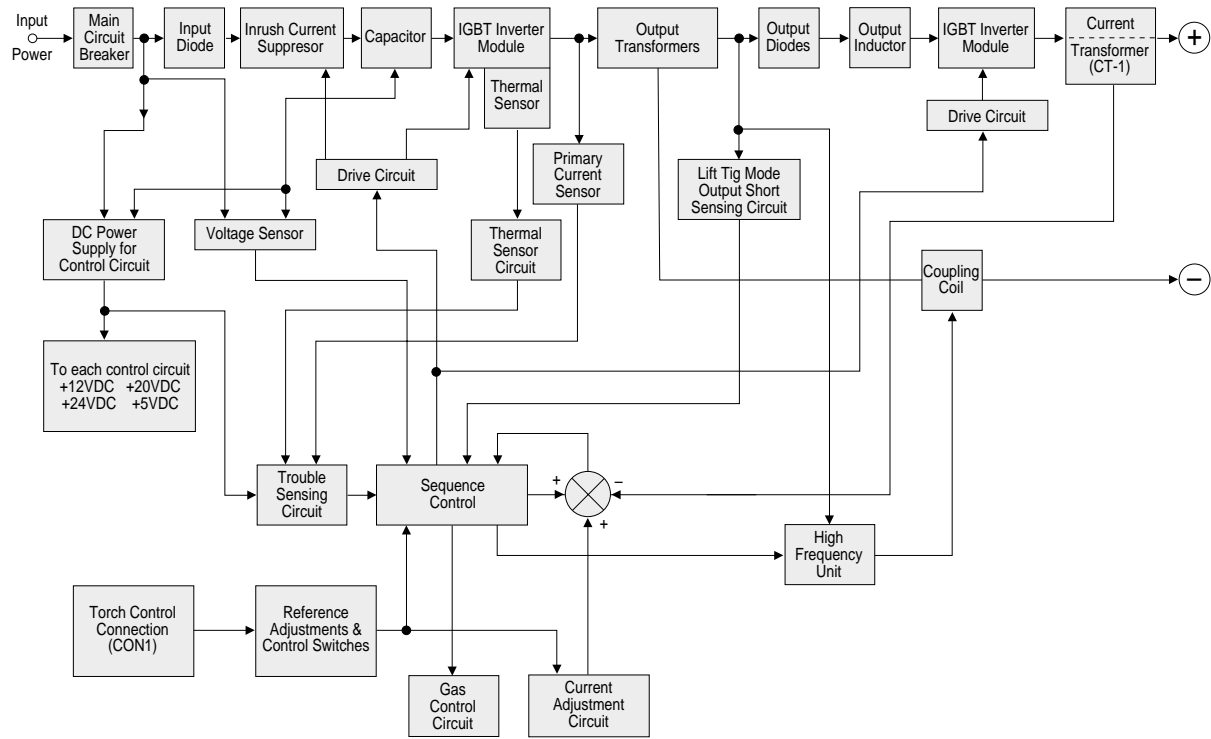

Figure 2. Functional block diagram

2.03 Transporting Methods

These units are equipped with a handle for carrying purposes.



WARNING ELECTRIC SHOCK can kill.

- DO NOT TOUCH live electrical parts.
- Disconnect input power conductors from de-energized supply line before moving welding power source.



WARNING FALLING EQUIPMENT can cause serious personal injury and equipment damage.

- Lift unit with handle on top of case.
- Use hand cart or similar device of adequate capacity.
- If using a fork lift vehicle, place and secure unit on a proper skid before transporting.

2.04 Electrical Input Connections



WARNING ELECTRIC SHOCK can kill; SIGNIFICANT DC VOLTAGE is present after removal of input power.

- DO NOT TOUCH live electrical parts.
- SHUT DOWN welding power source, disconnect input power employing lockout/tag out procedures. Lockout/tag out procedures consist of padlocking line disconnect switch in open position, removing fuses from fuse box, or shutting off and red-tagging circuit breaker or other disconnecting device.

Electrical Input Requirements

Operate the welding power source from a single or three-phase 50/60 Hz, AC power supply. The input voltage must match one of the electrical input voltages shown on the input data label on the unit nameplate. Contact the local electric utility for information about the type of electrical service available, how proper connections should be made, and inspection required.

The line disconnect switch provides a safe and convenient means to completely remove all electrical power from the welding power supply whenever necessary to inspect or service the unit.

NOTE

These units are equipped with a four-conductor with earth power cable that is connected at the welding power source end for single or three-phase electrical input power.

- **To operate single-phase, do not connect the RED input conductor.**
- Do not connect an input (WHITE, BLACK or RED) conductor to the ground terminal.
- Do not connect the ground (GREEN) conductor to an input line terminal.

Refer to figure 3 and:

1. Connect end of ground (GREEN) conductor to a suitable ground. Use a grounding method that complies with all applicable electrical codes.
2. Connect ends of line 1 (BLACK), line 2 (WHITE) and line 3 (RED) input conductors to a de-energized line disconnect switch.
3. Use Table 1 below as a guide to select line fuses for the disconnect switch.

Table 1. Fuse Size Selection

Model	Input Voltage	Fuse Size (Amperes)	
		Three-Phase	Single-Phase
208-230VAC	208-230VAC	60	125
208-230/460VAC	208-230VAC	60	125
	460VAC	23	75
380-415 VAC	380-415VAC	30	N/A

NOTE Fuse size is based on not more than 200 percent of the rated input amperage of the welding power source (Based on Article 630, National Electrical Code).

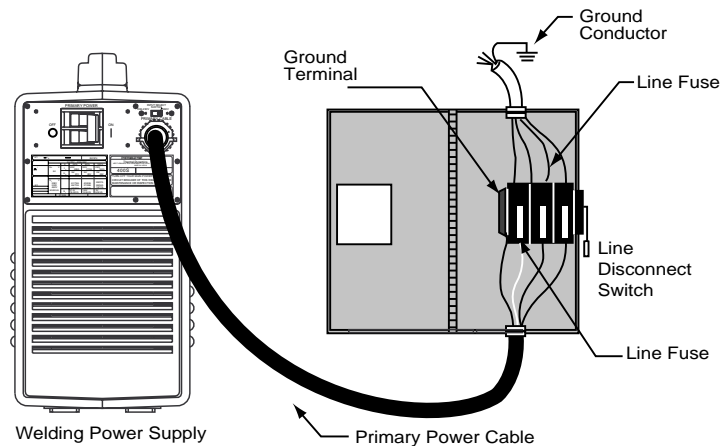

Figure 3. Electrical input connections

Input Power Each unit incorporates an INRUSH circuit and input voltage sensing circuit. When the MAIN CIRCUIT BREAKER is turned on, the inrush circuit provides a pre-charging of the input capacitors. SCR's in the Power Control Assembly will turn on after the input capacitors have charged to full operating voltage (after approximately 5 seconds).

2.05 Specifications

Parameter	208V/230V/460V					
	Three-Phase			Single-Phase		
Rated Output						
Amperes	300	250	300	250		
Volts	32	30	32	30		
Duty Cycle	25%	40%	25%	40%		
Output Range (Min. - Max.)	TIG/STICK					
Amperes	5-300 DC or 10-300 AC					
Volts	10-32					
Open Circuit Voltage						
Maximum OCV	64 V					
Input Data	50/60 Hz					
Dimensions/Weight						
Width	8.3 in (210 mm)					
Height	16.9 in (430 mm)					
Length	16.5 in (420 mm)					
Weight	46.2 lb (21 kg.)					
Output at Rated Output	Three-Phase			Single-Phase		No Load
Amperes	300	250	300	250		
Volts	32	30	32	30		
Duty Cycle	25%	40%	25%	40%		
KVA	15.7	12.3	19.8	15.5	0.5	
KW	12.2	9.5	12.5	9.8	0.3	
Output At No Load						
Input data 50/60 Hz/Duty Cycle						
KVA	0.5					
KW	0.3					
Input Volts	Amperage Draw					
	Three-Phase			Single-Phase		No Load
208	—	—	95	74	2.2	
230	—	—	86	67	2.2	
460	—	—	43	34	1.1	
208	44	34	—	—	1.4	
230	40	31	—	—	1.3	
380	24	19	—	—	0.8	
400	23	18	—	—	0.7	
415	22	17	—	—	0.7	
460	20	15	—	—	0.6	

2.06 Duty Cycle

The duty cycle of a welding power source is the percentage of a ten (10) minute period that it can be operated at a given output without causing overheating and damage to the unit. If the welding amperes decrease, the duty cycle increases. If the welding amperage are increased beyond the rated output, the duty cycle will decrease.



WARNING

Exceeding the Duty Cycle Ratings will cause the Thermal Overload Protection Circuit to become energized and shut down the output until the unit has cooled to normal operating temperature.

Continually exceeding the Duty Cycle Ratings can cause damage to the welding power source.

To calculate duty cycle:

$$\text{current} = \sqrt{\frac{(\text{rated current})^2 \times (\text{rated duty cycle})}{(\text{desired duty cycle})}}$$

i.e. At the 300A rated output current, and 25% rated duty cycle, the operator wants to work on a 50% duty cycle. The maximum allowable current draw is:

$$\text{current} = \sqrt{\frac{(300\text{A})^2 \times (.25)}{(.50)}}$$

$$\text{current} = \sqrt{90,000 \times (0.5)}$$

$$\text{current} = \sqrt{45,000}$$

$$\text{current} = 212.1\text{A}$$

3.0 OPERATOR CONTROLS

3.01 Front and Rear panel operator controls

- ① **Amperage Control** - The Amperage Control selects the desired amperage within the entire range of the welding power source. Rotating this control in a clockwise direction increases the amperage output. The scale surrounding the amperage control represents approximate actual amperage values.
- ② **Hot Start Control** - The Hot Start Control provides a variable selection of start circuit current that operates in the HF TIG modes. The Hot Start time is approximately 0.06 seconds in STICK. The current value is adjusted from 0 to 100 Amps over the determined weld current set by the Amperage Control. Rotating the control clockwise increases Hot Start current.
- ③ **ARC Control** - The Arc Control is in use in the SMAW mode only. Rotate the control clockwise to increase the short circuit current available to control the welding arc.
- ④ **Process Selector Switch** - The Process Selector Switch allows the operator to select the STICK welding (SMAW) process, LIFT TIG (GTAW) or HF TIG (GTAW) process.
- ⑤ **Warning Indicator** - The Warning Indicator located on the front panel will become activated under the following conditions:
 - Input voltage is too low
 - Input voltage too high
 - Thermal overload
- ⑥ **AC Power Indicator** - The AC Power Indicator located on the front panel lights when the Primary Power Switch is in the ON position, indicating the unit is energized
- ⑦ **Output Selector Switch** - Selects between AC or DC output
- ⑧ **Sloper Switch** - When in the OFF position the Sloper is inactive. Selecting the ON position activates the Sloper. Selecting the SPOT position activates the spot welding timer. The Slope sequence and spot modes are activated by a remote ON/OFF switch connected to the 8-pin receptacle. See the section on Slope sequence.
- ⑨ **Pulser Switch** - When in the OFF position the Pulser is inactive. Selecting H (HIGH) or L (LOW) will activate the TIG pulser. The Pulse Frequency can be adjusted by the Pulse Frequency control. Pulse width is fixed at 35%. Background current is fixed at 1/5th of the peak current.
- ⑩ **AC Frequency Control** - when Output Selector Switch is in AC position, controls frequency of AC waveform on output.
- ⑪ **Wave Balance** - This controls the portion of each AC output cycle that has its polarity reversed. The reverse polarity portion of the waveform is used to clean the oxides of aluminum as it is welded. The control is variable from 5% to 50%.
- ⑫ **Spot Time Up/Down Slope Control** - This control provides Spot, Up and Down slope time control. Rotating the control clockwise increases the time. The scale surrounding the control represents approximate actual values. The Spot and Up slope time is adjustable from 0.5 to 5 seconds. The Down slope time is twice the Up slope time at 0.5 to 10 seconds.
- ⑬ **Pulse Frequency Control** - The Pulse Frequency control provides a means of selecting the pulse frequency when the Pulse switch is in the H (HIGH) or L (LOW) position. Rotating the control clockwise increases the pulse frequency. The two scales surrounding the control represent approximate actual values. The pulse frequency is adjustable from 0.5 to 25 Hz in LOW and 10 to 500 Hz in HIGH.

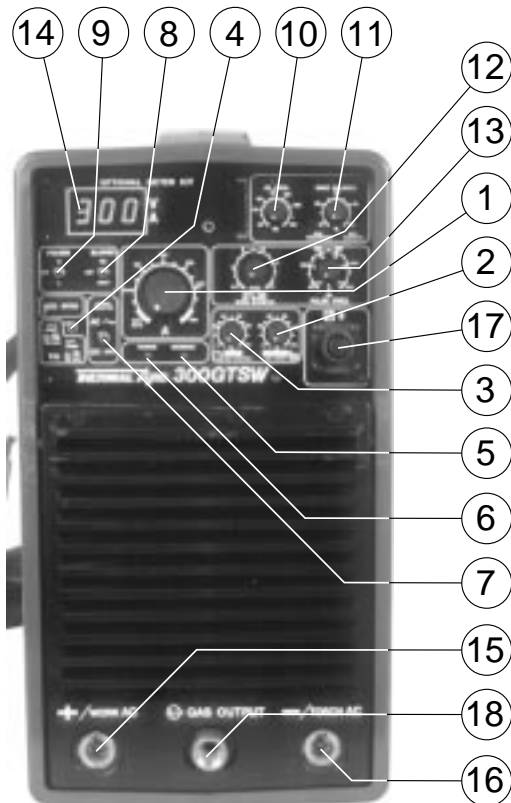

- ⑭ **LED Voltage/Amperage Display (optional)**
 - ⑮ **Positive Terminal** - 50mm DIN-style female receptacle.
 - ⑯ **Negative Terminal** - 50mm DIN-style female receptacle.
 - ⑰ **8-Pin Receptacle** - Used for remote contactor and amperage controls.
 - ⑱ **Output Gas Fitting** - Gas output; fitting size 5/8"-18 unf female
 - ⑲ **Output Gas Fitting** - European model gas output. Accommodates 3/8" BSP monocable TIG torch.
- Gas Solenoid** - The pre-flow is fixed at 150 ms. Post-flow is automatically adjusted from 1 to 30 seconds by the position of the welding Amperage Control.
- Sloper Sequence** -
- A. Remote ON/OFF switch closed** - Pre-flow starts to flow. In HF TIG mode HF and initial current is present after pre-flow. (In LIFT TIG mode HF is not present.) Initial current is 1/5th of the welding current.
 - B. Remote ON/OFF switch opened** - Current increases to welding current at the rate set by the UP/DOWN Slope control. Welding current is set by the Amperage Control.
 - C. Remote ON/OFF switch closed** - Current decreases to final current at twice the rate set for UP Slope. Final current is 1/5th of welding current.
 - D. Remote ON/OFF switch opened** - Arc shuts off and post-flow time initiated.
- Note:** A remote ON/OFF device with current control will disable the SLOPER.

Figure 4. Front panel operator controls

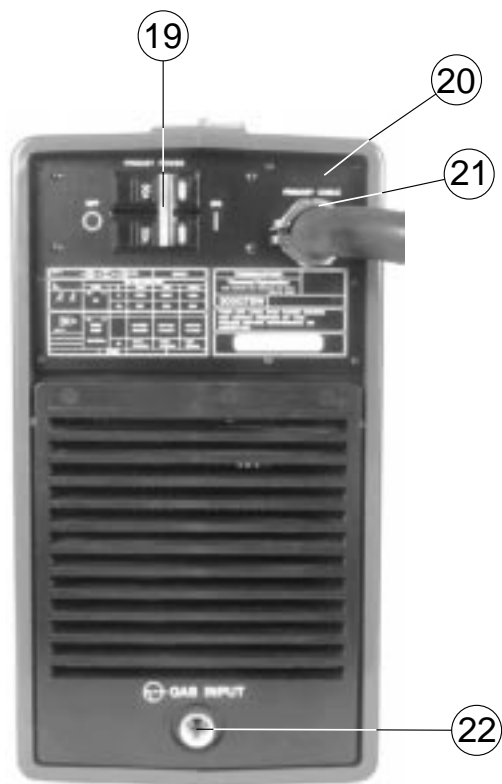

- ① **Primary Power Switch** - Placing the Primary Power Switch (circuit breaker) located on the rear panel to the ON position energizes the welding power source.
- ② **Voltage Selector** - Manual slide switch selects the proper input voltage range. (208-230/460VAC Model only)
- ③ **Input Cable** - 10 feet
- ④ **Input Gas Fitting** - The input gas connection is located on the bottom center of the rear panel. Size 5/8"-18 unf female, European Fitting - 3/8" BSP male.

Figure 5. Rear panel operator controls (208/230 model shown)

3.02 Setup for Operation



Arc Control

The ARC CONTROL provides a variable selection of short circuit amperage to suit individual welding situations when operating in the STICK welding (SMAW) mode.

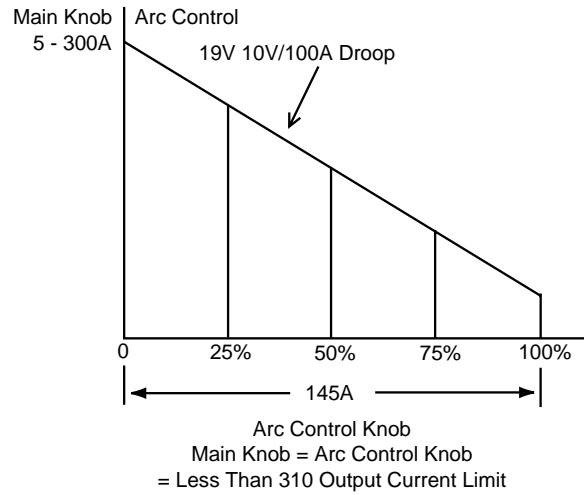

Figure 6. Arc Control Characteristics

3.02 Setup for Operation

Shielded Metal Arc Welding (SMAW) DC or AC Operation



WARNING Read and follow all safety precautions on pages iii-v of this manual before preceding with operation.

1. Install and connect unit according to the installation instructions in section 2.04, page 17, of this manual.
2. Wear dry insulating gloves and clothing.

For DC Operation

3. Connect the ground cable (work clamp) to clean, bare metal on workpiece. For the majority of electrodes in use, the work clamp is connected to the NEGATIVE (-) output terminal.
4. Select proper electrode.
5. Refer to Operator Control section, page 21, and set the controls per the following:
 - a. PROCESS SELECTOR switch [4] to STICK position.
 - b. Rotate the AMPERAGE control [1] to output current level desired.
 - c. Set OUTPUT SELECTOR SWITCH to DC.



6. Insert electrode into electrode holder. For the majority of electrodes in use, the electrode holder is connected to the POSITIVE (+) output terminal.
7. Wear welding helmet with proper filter lens according to ANSI Z49.1.
8. Place the PRIMARY POWER switch [19] to ON.
9. Begin welding.

NOTE When in the STICK mode, the PULSER and SLOPER controls will not operate. The Output Contactor is on when the 300GTSW is in the STICK mode.

For AC Operation

3. Connect the ground cable (work clamp) to clean, bare metal on workpiece. The work clamp is connected to the POSITIVE (+) output terminal.
4. Select proper electrode.
5. Refer to Operator Control section, page 21, and set the controls per the following:
 - a. PROCESS SELECTOR switch [4] to STICK position.
 - b. Rotate the AMPERAGE control [1] to output current level desired.
 - c. Set OUTPUT SELECTOR SWITCH to AC.
 - d. Adjust AC FREQUENCY CONTROL to suit welding conditions; usually set at MAXIMUM.
 - e. Adjust WAVE BALANCE Control to suit welding conditions; usually set at MAXIMUM.
 - f. Adjust HOT START to suit welding conditions.
6. Insert electrode into electrode holder. The electrode holder is connected to the NEGATIVE (-) output terminal.
7. Wear welding helmet with proper filter lens according to ANSI Z49.1.
8. Place the PRIMARY POWER switch [19] to ON.
9. Begin welding.

NOTE

When in the STICK mode, the PULSER and SLOPER controls will not operate. The Output Contactor is on when the 300GTSW is in the STICK mode.

3.02 Setup for Operation

Gas Tungsten Arc Welding (GTAW) High Frequency/Lift Start



WARNING Read and follow all safety precautions on pages 2-5 of this manual before preceding with operation.

1. Install and connect unit according to the installation instructions in section 2.04, page 17, of this manual.
2. Select proper tungsten electrode (refer to Electrode Selection Table 2, page 30).
3. Prepare tungsten electrode and insert into torch, the TIG TORCH is connected to the NEGATIVE (-) output terminal.
4. Wear dry insulating gloves and clothing.
5. Connect shielding gas supply to gas fitting on back panel.
6. Connect TIG torch gas fitting to output 3/8" BSP or 5/8"-18 UNF fitting where applicable.
7. Connect remote control device to 8-pin receptacle.



NOTE The maximum output that can be obtained using the remote control is set by the main current knob.

8. Connect work clamp to clean, bare metal on workpiece, the work clamp is connected to the POSITIVE (+) output terminal.
9. Refer to the Operator Control section and set the controls per the following:
 - a. PROCESS SELECTOR switch [4] to desired Gas Tungsten Arc Welding position LIFT Start or HF Start TIG.
In this position, the unit provides weld output for the Gas Tungsten Arc Welding (GTAW) process. High frequency will be

HF START
(GTAW with High Frequency Start)

present from the time the contactor is closed until a welding arc is established. Once an arc is established, high frequency is no longer present. High frequency is present any time the arc is broken to aid in restarting the arc as long as the contactor is energized. When the PROCESS SELECTOR switch is in this position, the ARC CONTROL will not function but the HOT START will.

NOTE

If using HOT START in GTAW mode: Set below Maximum current capacity of electrode (Table 2, page 30).

LIFT START
(GTAW without High Frequency)

In this mode, the unit provides weld output for the Gas Tungsten Arc Welding (GTAW) process. High frequency will not be present. When the PROCESS SELECTOR switch is in this position, the HOT START ARC CONTROL will not function. The unit will provide a low open circuit voltage and approximately 15 amps to the tungsten electrode when touched to the work. After the Tungsten Electrode is lifted away and the welding arc becomes established, the output current will be regulated at the current level determined by the AMPERAGE control [1].

- b. Rotate the AMPERAGE control [1] to output current level desired.
- c. Set AC/DC switch to desired welding output.

NOTE

In AC mode connect the TIG torch to the negative output receptacle. *If monocable TIG torch is used connect to 3/8" BSP fitting.

- 8. Turn on shielding gas.
- 9. Wear welding helmet with proper filter lens according to ANSI Z49.1.
- 10. Place the PRIMARY POWER switch [19] to ON.
- 11. Activate remote control device.
 - a. In LIFT TIG mode, touch electrode to work and lift to start arc.
 - b. In HF TIG mode, high frequency will start, followed by welding arc.
- 12. Begin welding.

NOTES



WARNING

HIGH CONCENTRATION OF SHIELDING GAS can impair health or kill. Shut off gas supply when not in use.

3.01 Setup for Operation

Gas Tungsten Arc Welding-Pulsed (GTAW-P) -Sloped (GTAW-S) -TIG Spot



WARNING Read and follow all safety precautions on pages 2-5 of this manual before preceding with operation.

1. Install and connect unit according to the installation instructions in section 2.04, page 17, of this manual.
2. Select proper tungsten electrode (refer to Electrode Selection Table 2, page 30).
3. Prepare tungsten electrode and insert into torch, connect to the NEGATIVE (-) output terminal.
4. Wear dry insulating gloves and clothing.
5. Connect shielding gas supply to gas fitting on back panel.
6. Connect TIG torch gas fitting to output 3/8" BSP or 5/8"-18 UNF fitting where applicable.
7. Connect remote control device to 8-pin receptacle.
8. Connect work clamp to clean, bare metal on workpiece, the work clamp is connected to the POSITIVE (+) output terminal.
9. PROCESS SELECTOR switch [4] to desired gas tungsten arc welding position. LIFT or HF TIG.
 - a. Set AC/DC switch to desired welding output.
10. Refer to the Operator Control section, page 21, and set the controls per the following:

NOTE In AC mode connect the TIG torch to the negative output receptacle. *If monocabable TIG torch is used connect to 3/8" BSP fitting.

A. PULSE TIG welding

1. Set PULSER SELECTOR switch [9] to desired frequency pulse of high or low.
2. Rotate the AMPERAGE control [1] to desired output current level.
3. Rotate PULSE FREQUENCY control [13] to desired frequency position.

B. SLOPE TIG welding

1. Set SLOPER switch [8] to SLOPE position.
2. Rotate AMPERAGE control [1] to desire welding current level.
3. Rotate SPOT TIME UP/DOWN SLOPE control [12] to desired UP/DOWN slope time.

NOTE Only use a remote ON/OFF switch to control SLOPE sequence. See the Operator Control section on page 21.

C. SPOT TIG welding

1. Set SLOPER switch [8] to SPOT position.
2. Rotate AMPERAGE control [1] to desired spot welding current level.

NOTE: the SPOT TIMER is disabled in the LIFT TIG mode. To use the SPOT TIMER, use the HF START.

In the LIFT TIG mode, touch the electrode to work and lift to start arc.

3. Rotate SPOT TIME UP/DOWN SLOPE control [12] to desired SPOT welding time.



11. Turn on shielding gas and water supplies as applicable.
12. Wear welding helmet with proper filter lens according to ANSI Z49.1.
13. Place the PRIMARY POWER switch [19] to ON.
14. Activate the remote control device.
 - a. In the LIFT TIG mode, touch the electrode to work and lift to start arc.
 - b. In the HF TIG mode, the high frequency will start, followed by welding arc.
15. Begin welding.

NOTES



WARNING

HIGH CONCENTRATION OF SHIELDING GAS can impair health or kill. Shut off gas supply when not in use.

Shutting Down

16. Stop welding.
17. Move the PRIMARY POWER switch [19] to the OFF position.
18. Turn off the shielding gas and water supplies if applicable.

Table 2. Electrode Selection Table

Electrode/Diameter	Amperage Range		
	DC-Argon Electrode Negative/Straight Polarity	DC-Argon Electrode Positive/Reverse Polarity	AC/Argon
Pure Tungsten (Green Band)			
0.010 in. (0.25mm)	1-15	—	1-15
0.020 in. (0.51mm)	5-20	—	5-20
0.040 in. (1.02mm)	15-80	—	10-60
1/16 in. (1.59mm)	70-150	10-20	50-100
3/32 in. (2.38mm)	125-225	15-20	100-160
1/8 in. (3.18mm)	225-360	25-40	150-210
5/32 in. (3.97mm)	360-450	40-55	200-275
3/16 in. (4.76mm)	450-720	55-80	250-350
1/4 in. (6.35mm)	720-950	80-125	325-450
2% Thorium Alloyed Tungsten (Red Band)			
0.010 in. (0.25mm)	1-25	—	1-25
0.020 in. (0.51mm)	15-40	—	15-35
0.040 in. (1.02mm)	25-85	—	20-80
1/16 in. (1.59mm)	50-160	10-20	50-150
3/32 in. (2.38mm)	135-235	15-30	130-250
1/8 in. (3.18mm)	250-400	25-40	225-360
5/32 in. (3.97mm)	400-500	40-55	300-450
3/16 in. (4.76mm)	500-750	55-80	400-500
1/4 in. (6.35mm)	750-1,000	80-125	600-800

Table 3. Weld Cable Size

	Maximum Total Cable Length in Weld Circuit							
	Under 100 ft. (Under 30m)		150 ft. (45m)	200 ft. (60m)	250 ft. (70m)	300 ft. (90m)	350 ft. (105m)	400 ft. (120m)
Duty Cycle	100-60%	60-100%			10-100%			
Welding Amperes								
100	4	4	4	3	2	1	1/0	1/0
150	3	3	2	1	1/0	2/0	3/0	3/0
200	3	2	1	1/0	2/0	3/0	4/0	4/0
250	2	1	1/0	2/0	3/0	4/0	2-2/0	2-2/0
300	1	1/0	2/0	3/0	4/0	2-2/0	2-3/0	2-3/0
400	1/0	2/0	3/0	4/0	2-2/0	2-3/0	2-4/0	2-4/0

4.0 BASIC TROUBLESHOOTING

General	Troubleshooting and repairing this unit is a process which should be undertaken only by those familiar with high voltage, high power electronic equipment.
 WARNING	There are extremely dangerous voltage and power levels present inside this unit. Do not attempt to diagnose or repair unless you have had training in power electronics measurement and troubleshooting techniques.

4.01 Common Welding Operation Faults

The following are some of the more common operating faults that occur during welding operations:

A. Power

- Main power not connected
- Main power not turned on
- MAIN CIRCUIT BREAKER set of OFF position
- INPUT SELECTOR (Easy Link) Switch in wrong position

B. Poor Weld

- Wrong polarity
- Wrong electrode used
- Electrode not properly prepared
- Incorrect welding amperage setting
- Speed too slow or too fast
- Incorrect switch settings for intended operation
- Poor weld output connection(s)

C. Remote Operation

- Incorrect contactor switch settings
- Remote not connected

If the problem is not resolved after checking the above, the following guide may suggest more specific items to check given the faulty operating symptom(s) you are experiencing.

4.02 Specific Problems

How to Use This Guide

The following information is a guide to help you determine the most likely causes for various symptoms.

This guide is set up in the following manner:

A. Symptom (Bold Type)

- Any special instructions (Text Type)
 1. Cause (*Italic Type*)
 - a. Check/Remedy (Text Type)

Locate your symptom, check the cause(s) (the simplest or most likely is listed first), then perform the remedy given. Repair as needed being sure to verify that the unit is fully operational after any repairs.

A. No Weld Output; Unit is Completely Inoperative

1. *Line disconnect switch is in OFF position*
 - a. Place line disconnect switch in ON position.
2. *Line fuse(s) open*
 - a. Check and replace line fuse(s).
3. *Improper electrical input connections*
 - a. See Section 2.04 Electrical Input Requirements, page 17, for proper input connections.
4. *MAIN CIRCUIT BREAKER in OFF position*
 - a. Check and reset MAIN CIRCUIT BREAKER if necessary.
5. *INPUT SELECTOR (Easy Link) switch is set to incorrect position for applied input voltage, 208/230/460 model only*
 - a. Verify primary source voltage and set INPUT SELECT switch to correct setting.

B. WARNING Indicator is ON

1. *Unit is in thermal shutdown mode*
 - a. Allow cooling period of approximately five (5) minutes with the power ON. Duty cycle should be reviewed. To reset the WARNING indicator, the power supply must be turned OFF, then ON again.
2. *Input voltage is low*
 - a. Measure input voltage and verify that it matches the INPUT SELECTOR (Easy Link) switch setting. The length of the input power cable must be considered, as there will be a considerable voltage drop along its length.
3. *Irratic input voltage – spikes over tolerance will cause the warning light to come on for protection*
 - a. Turn MCB off then on to reset the warning light.

C. Erratic or Improper Weld Output

1. *Loose welding cable connections*
 - a. Tighten all welding cable connections.
2. *Incorrect welding cable size*
 - a. Use proper size and type of cable (see Table 2, page 29).
3. *Improper input connections*
 - a. Refer to Section 2.04 Electrical Input Requirements, page 17.
4. *Poor electrode condition*
 - a. Replace electrode.
5. *If in GTAW mode, check the condition of the tungsten electrode*
 - a. Use the recommended 2% Thoriated tungsten.
6. *In GTAW mode, incorrect argon gas flow*
 - a. Verify that argon gas flow is correct; approximately 12 SCFH.
7. *Incorrectly set PROCESS SELECTOR switch*
 - a. Verify the PROCESS SELECTOR switch is set to match the type of welding process being conducted.
8. *Wrong welding polarity*
 - a. Verify output torch connections.

D. Wandering Arc, Poor Control of Arc Direction

1. *Wrong size tungsten electrode, typically larger than recommended*
 - a. Use proper size electrode for amperage selected (see Table 2, page 29).
2. *Improperly prepared tungsten electrode*
 - a. Prepare tungsten properly.
3. *Gas Flow rate too high*
 - a. Reduce flow rate to approximately 12 SCFH.
4. *Drafts blowing shielding gas away from tungsten electrode*
 - a. Shield weld zone from drafts and check condition of tungsten electrode.
5. *Loose gas fitting on regulator or gas line drawing air into weld zone, causing green/blue discoloration of workpiece*
 - a. Check and tighten all gas fittings.
6. *Water in torch*
 - a. Refer to torch parts list for part(s) requiring replacement and repair torch as necessary.

E. No High Frequency at Torch When PROCESS SELECTOR Switch is in HF TIG Position

1. *PROCESS SELECTOR switch is not in the HF TIG position*
 - a. Place switch in HF TIG position.
2. *Drafts blowing shielding gas away from tungsten electrode*
 - a. Shield weld zone from drafts and check condition of tungsten electrode.
3. *Loose gas fitting on regulator or gas line drawing air into weld zone*
 - a. Check and tighten all gas fittings.
4. *Water in torch*
 - a. Refer to torch parts list for part(s) requiring replacement and repair torch as necessary.
5. *Tungsten condition is poor*
 - a. Replace electrode.
6. *Electrode too high off metal*
 - a. Reduce stand-off.
7. *Faulty TIG Torch*
 - a. Replace TIG torch.
8. *Work lead not connected*
 - a. Verify all connections to torch and workpiece.

F. Lack of High Frequency; Difficulty in Establishing an Arc

1. *Dissipation of high frequency from torch cable or conductive gas hose*
 - a. Be sure that the torch cable is not near any grounded metal. Do not use conductive gas hose.
2. *Weld cable leakage*
 - a. Check cables and torch for cracked or deteriorated insulation or bad connections. Repair or replace necessary parts.
3. *Poor ground connection to power supply*
 - a. Verify ground by trying to strike arc within one inch (2.54cm) of ground clamp.

G. Wall Fuse/Circuit Breaker Trips When Turned ON

1. *Input voltage over rated limit*
 - a. Connect to proper line voltage.

H. Green AC POWER Indicator OFF; Fan Not Operating

1. *Input line disconnect switch in OFF position*
 - a. Place input line disconnect switch to ON position.
2. *Power supply MAIN CIRCUIT BREAKER (MCB) in OFF position*
 - a. Place MCB to ON position.
3. *Input line breaker tripped/fuses blown*
 - a. Reset MCB; check primary supply breaker or fuses and replace if necessary. Refer to letter G above.

NOTE Verify that for single-phase operation, the RED input line is not connected.

4. *Open conductor in input power line*
 - a. Check continuity and replace if necessary.

I. Red WARNING Indicator ON; No Weld Output

1. *Input voltage fluctuation causing protection circuits to activate*
 - a. Monitor input power for spikes and high voltage conditions. Most power utilities will monitor and verify line voltage.
2. *Thermal sensor TH1 open (thermal shutdown)*
 - a. Allow the unit to cool for five minutes before turning the power supply ON.

J. No Weld or Output; Fan Operating; WARNING Indicator OFF

1. *Faulty Remote Control Device*
 - a. Connect a jumper between pins 2 and 3 of the REMOTE 8 receptacle for contactor closure. If amperage and voltage can be adjusted with front panel controls, repair or replace remote control device.

K. Low or Maximum Weld Output With No Control

1. *Faulty remote control device*
 - a. Connect a jumper between pins 2 and 3 of the REMOTE 8 receptacle for contactor closure. If amperage and voltage can be adjusted with front panel controls, repair or replace remote control device.

L. Limited Weld Output

1. *Poor primary input voltage*
 - a. Check primary input voltage is within $\pm 10\%$ of nominal voltage, i.e. 230VAC $\pm 10\%$.

M. Erratic or Improper Weld Output

1. *Loose welding cable connections*
 - a. Tighten all welding cable connections.
2. *Improper setup*
 - a. Check for proper connection of input power.

3. *Faulty Remote Device*

- a. Check all remote devices and repair or replace if necessary.

4. *Tungsten condition is poor, causing discoloration of workpiece*

- a. Replace electrode.

N. No Weld Output; Fan Not Operating; WARNING Indicator OFF

1. *Line voltage too low*

- a. Verify that input voltage matches setting on rear panel INPUT SELECTOR switch.

4.03 REMOTE 8-Pin Connections

The REMOTE 8-Pin receptacle is used to connect any of the following equipment to the welding power source circuitry:

- Remote Hand Pendant
- Remote Foot Control
- Remote Contactor Control
- Remote Amperage Control

To make connections, align keyway, insert plug, and rotate threaded collar fully clockwise. The socket information is included in the event the supplied cord is not suitable and it is necessary to wire a plug or cord to interface with the REMOTE 8-Pin receptacle.

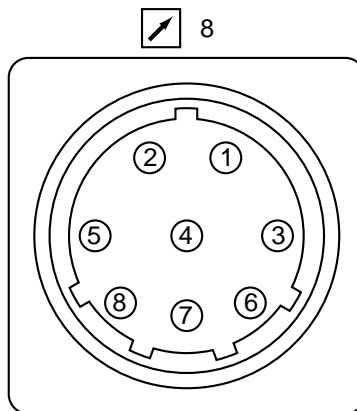

Socket	Function
1	Chassis common
2	Remote contactor control when contact closure is provided between sockets 2 and 3 (GND)
3	Remote contactor control when contact closure is provided between sockets 2 and 3 (+24 V DC)
4	Remote amperage control when contact closure is provided between sockets 4 and 8 (+12 V DC)
5	Amperage remote control (MINIMUM); PC board common; use as return for remote control inputs/outputs
6	Amperage remote control (MAXIMUM) input command signal; +4 volts for maximum
7	Remote amperage reference signal (WIPER); 0 volts to +4 volts (peak current set by main rheostat)
8	Remote amperage control when contact closure is provided between sockets 4 and 8 (SIGNAL)

Figure 7. REMOTE 8-Pin Connections

APPENDIX A – ACCESSORIES

REMOTE CONTROL	CAT. NO	ARC ON/OFF CONTROL	CURRENT CONTROL	LENGTH	CONNECTORS	APPLICABLE TORCH HANDLE
Digital Meter Kit	10-4000	Current and Voltage Display with Hold Feature and Preview				
Adapter 8 to 14 Pin	10-4003	X	X	6"/150mm	8-Pin (Male)	N/A
Dinse Connector	10-4020	50mm Dinse Style Plug (two included with each power supply)				
Torch Switch TIG	10-4008	X	X	15/4.6m	8-Pin (Male)	5/8" - 7/8"/16mm-22mm
Torch Switch TIG	10-4009	X	X	15/4.6m	8-Pin (Male)	7/8" - 1 1/8"/22mm-29mm
Torch Switch TIG	10-4010	X	X	15/4.6m	8-Pin (Male)	1 1/8" - 1 3/8"/29mm-35mm
Torch Switch TIG	10-4011	X	X	25/7.6m	8-Pin (Male)	5/8" - 7/8"/16mm-22mm
Torch Switch TIG	10-4012	X	X	25/7.6m	8-Pin (Male)	7/8" - 1 1/8"/22mm-29mm
Torch Switch TIG	10-4013	X	X	25/7.6m	8-Pin (Male)	1 1/8" - 1 3/8"/29mm-35mm
Hand Pendant	10-4014	X	X	25/7.6m	8-Pin (Male)	N/A
Foot Control	10-4015	X	X	15/4.6m	8-Pin (Male)	N/A
Foot Control	10-4016	X	X	25/7.6m	8-Pin (Male)	N/A
Gas Hose	9-2146			10'/3.04m	Inert Gas	High Purity Hose

Miscellaneous Accessories (Kits are provided assembled ready to use)

Item	Catalog No.	Description
TIG Kit-300GTSW	10-4081	Includes: Arcair BG-26-12 TIG Torch w/ accessory kit, 10ft. gas hose Victor 580
Gas Cooled		HRF 1425-regulator, Ground lapm w/ 12ft. cable and 50mm Dinse Connector attached
STICK Kit	10-4082	Electrode Holder w/ 15ft. cable and 50mm Dinse-style Connector attached Ground Clamp w/ 12ft. cable and 50mm Dinse-style Connector attached
Dinse TIG Block	10-2023	Air Colled (#26 style) 7/8-14 R.H.
Dinse TIG Block	10-2028	Air Colled (#17 style) 3/8-24 R.H.
Dinse TIG Block	10-2027	Water Cooled (#20 style) 7/8-14 L.H.
Power Block Adapter	10-4026	1/2" Stud to connect 45 VII type TIG Block (Requires 10-2021 DINSE to Tweco 2 MBP)
Torch Coolant	7-2850	For Water Cooled TIG Torches, specially formulated low conductivity
Cart	10-4035	Designed to hold power supply

Specifications						
	Duty Cycle	Output Amps	Output Voltage	No. Phase	Input Amps Single Phase	Input Amps Three Phase
Max Output	25%	300	32	1 or 3	86 amps	40 amps
Rated Load	40%	250	25	1 or 3	31 amps	17 amps
No Load Idle	Idle	-	-	1 or 3	.5 amp/.3KV	.2 amp

Output Range: 5-300 amps DC, 1 or 3 Phase
Standards: IEC 974-1 (IP23S), CSA NEMA, CE
10-300 amsp AC, 1 or 3 Phase Dimensions: Height: 16.9"/430mm
Maximum OCV: 64vac for 208-460 vac Width: 8.25"/210mm Depth: 16.5"/420mm
Input Frequency: 50/60 Hz Weight: 67 lbs./30.5kg

APPENDIX B – INTERCONNECTION DIAGRAMS

The following pages contain the interconnection diagrams for all 300GTSW models in current production, to aid in the identification of replacement parts.

