



Advanced Research Systems, Inc.

TECHNICAL MANUAL

EXPANDERS

MODELS DE-202 AND DE-204

www.arscryo.com

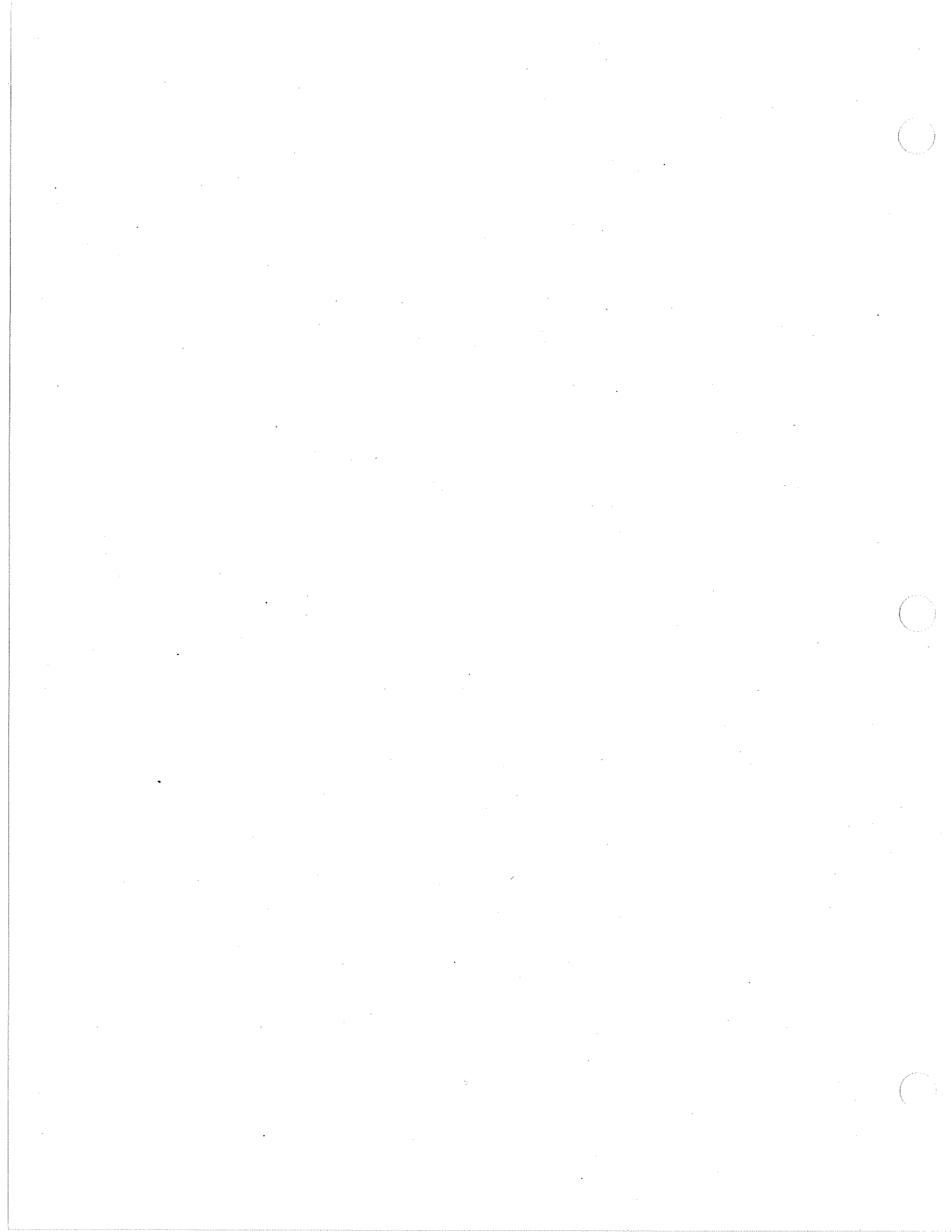
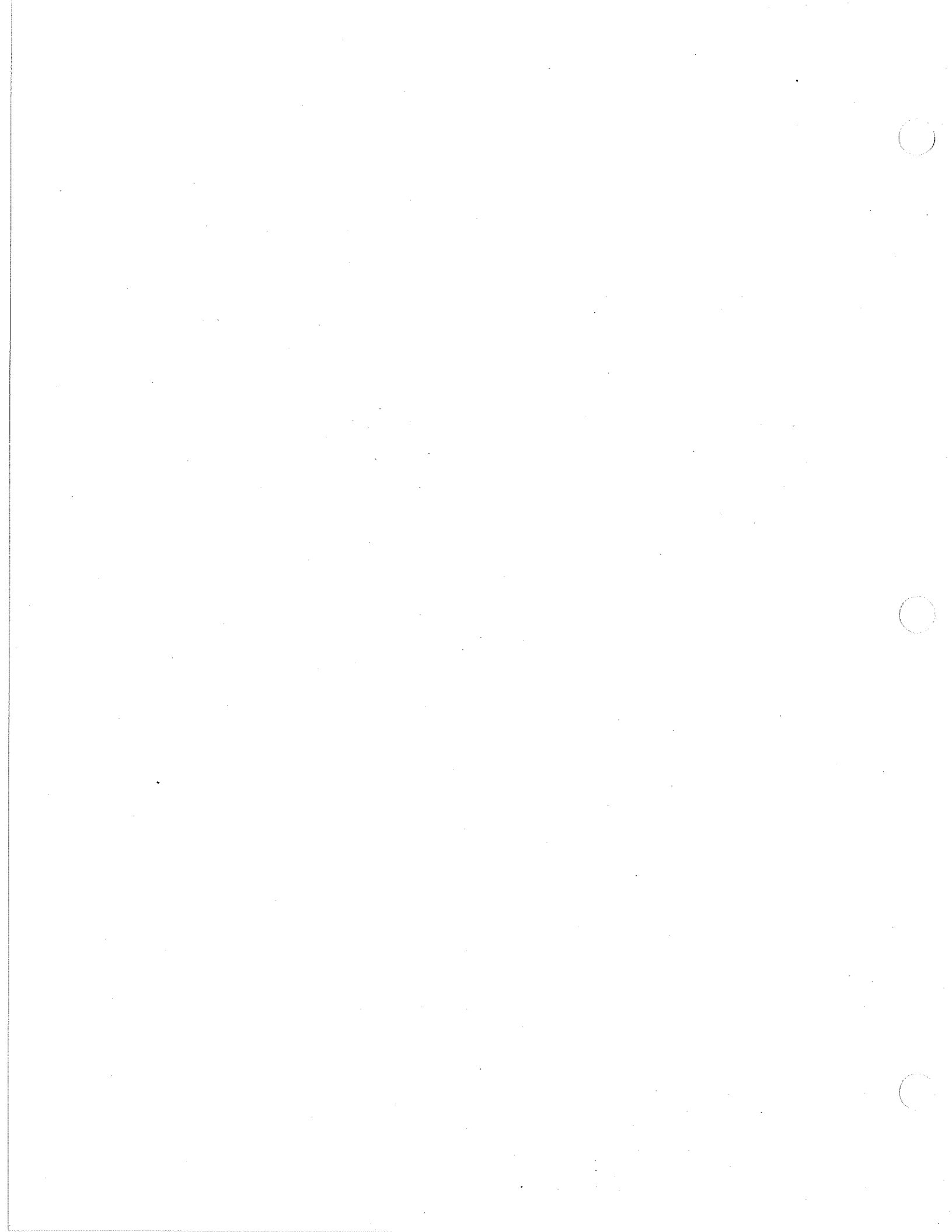



Table of Contents

Safety	1
Introduction	5
Installation	7
Operation	9
Removal	10
Maintenance	12
Troubleshooting	23
Parts	27





Advanced Research Systems, Inc.

Safety

General

ARS Inc. expanders are designed to operate safely with only original ARS Inc. parts and when the installation and servicing are performed in accordance with the instructions in this manual.

CAUTION !

Modification of the equipment without the approval of ARS Inc. will void the warranty.

Contact ARS Inc. with any questions you have concerning the use or maintenance of this equipment:

Advanced Research Systems, Inc.

Suite 109

905 Harrison Street

Allentown, PA 18103 USA

tel: 610 439 8022

fax: 610 439 1184

email: ars@arscryo.com

service email: arsservice@arscryo.com

web: www.arscryo.com

WARNINGS, Cautions, NOTES

Three types of special notices are presented throughout this manual:

⚠ WARNING

WARNINGS CALL ATTENTION TO ACTIONS OR CONDITIONS WHICH CAN RESULT IN INJURY OR DEATH TO PERSONNEL.

CAUTION !

Cautions call attention to actions or conditions which can result in damage to the equipment or in abnormal performance.

NOTE

NOTES GIVE IMPORTANT ADDITIONAL INFORMATION, EXPLANATIONS, OR RECOMMENDATIONS.

All warnings, cautions, and notes appear in the text where they are especially applicable. Because of their importance, they are summarized on the following pages:



⚠ WARNING

ALWAYS WEAR EYE PROTECTION WHEN HANDLING ANY PRESSURIZED EQUIPMENT.

⚠ WARNING

NEVER APPLY HEAT TO ANY PRESSURIZED EQUIPMENT.

⚠ WARNING

NEVER USE HELIUM GAS FROM A CYLINDER WITHOUT A PROPER PRESSURE REGULATOR AND PROPERLY RATED TUBING AND FITTINGS.

⚠ WARNING

WHEN BREAKING A VACUUM WITH GAS, DO NOT EXCEED ATMOSPHERIC PRESSURE.

⚠ WARNING

ALLOW THE EXPANDER TO WARM TO ROOM TEMPERATURE BEFORE DISCONNECTING THE GAS LINES. COLD GAS, IF TRAPPED IN THE EXPANDER, CAN REACH DANGEROUSLY HIGH PRESSURE IF ALLOWED TO WARM.

⚠ WARNING

USE 2 WRENCHES TO DISCONNECT GAS LINES FROM THE EXPANDER TO AVOID LOOSENING THE EXPANDER COUPLING.

⚠ WARNING

BEFORE REMOVING THE VALVE MOTOR HOUSING BOLTS ON THE EXPANDER IN ORDER TO PERFORM MAINTENANCE, VENT ALL GAS FROM THE EXPANDER FROM BOTH THE SUPPLY (RED) AND RETURN (GREEN) COUPLINGS.

⚠ WARNING

PERMIT ONLY QUALIFIED ELECTRICAL TECHNICIANS TO OPEN ELECTRICAL ENCLOSURES, OR TO PERFORM TESTS WITH THE POWER SUPPLY CONNECTED AND WIRING EXPOSED.



CAUTION !

Before connecting the gas lines to the compressor or expander, check that the face seal ring on the male coupling is in good condition, and that the faces of both mating couplings are clean.

CAUTION !

Never open the vacuum valve when connected to a vacuum pump that is off.

CAUTION !

Verify the electrical supply power frequency matches the frequency on the expander label. The expander is set at the factory for operation at either 50 Hz or 60 Hz.

CAUTION !

Do not get contaminants (particulates, moisture, oils or solvents, etc.) inside the expander.

CAUTION !

Do not damage, and keep clean, the mating surfaces between the valve disc and valve stem.

CAUTION !

Do not apply any lubricant to the valve disc, displacer seals or seal o-rings.

CAUTION !

Do not install a dirty or blemished valve disc or valve stem in the expander.

CAUTION !

Do not use any solvents or greases on the displacer assembly, seals, or seal o-rings.

CAUTION !

Do not substitute the o-rings used on the displacer seals. Use only factory-supplied o-rings. They are a special compound and durometer.

CAUTION !

Modification of the equipment without the approval of ARS Inc. will void the warranty.



NOTE

KEEP THE DUST CAPS OR PLUGS ON UNUSED GAS COUPLINGS.

NOTE

THE EXPANDER MAY BE NOISY DURING COOLDOWN, BUT THE NOISE LEVEL WILL DECREASE TO A NORMAL MINIMUM AS IT REACHES THE COOLDOWN TEMPERATURE.

NOTE

IT IS PREFERRABLE TO BREAK VACUUM WITH DRY GAS TO MINIMIZE ACCUMULATION OF MOISTURE IN THE VACUUM SPACE. IF THE INSULATING VACUUM IS BROKEN WHEN THE EXPANDER IS COLD, THEN THE OUTSIDE OF THE VACUUM ENCLOSURE WILL FROST OR BECOME WET.

NOTE

YOU NEED BOTH THE SERVICE TOOL KIT AND THE MAINTENANCE KIT FOR THE SPECIFIC EXPANDER BEFORE DISASSEMBLING THE EXPANDER FOR MAINTENANCE. YOU WILL ALSO NEED A PRECISION SURFACE PLATE, A 0-1 in (0-25 mm) MICROMETER, AND MASKING TAPE TO PROPERLY DRESS THE DISPLACER 2ND STAGE SEALS.

NOTE

DO NOT DISASSEMBLE THE EXPANDER UNLESS THE PROPER HELIUM GAS AND RE-FILLING EQUIPMENT ARE AVAILABLE. USE ONLY 99.999% ULTRA-PURE HELIUM GAS WITH A DEW POINT LESS THAN -50 C (-58 F) AT 300 PSIG (2069 kPa).

NOTE

USE 2 FILL/VENT FITTINGS, P/N 001075, WITH 1 EACH ATTACHED TO THE SUPPLY (RED) AND RETURN (GREEN) GAS COUPLINGS ON THE EXPANDER.

NOTE

WEAR CLEAN LINTLESS GLOVES. KEEP PARTS, WORK AREA, AND TOOLS CLEAN.

NOTE

PERFORM THE FOLLOWING SERVICE WITHIN 3 HOURS. THE DISPLACER ASSEMBLY IS SENSITIVE TO HUMIDITY. LONGER EXPOSURE WOULD REQUIRE IT TO BE VACUUM BAKED > 12 HOURS @ 80 C AND < 1 torr TO DRY IT.

NOTE

DO NOT FIT AN O-RING INTO THE WELD RELIEF GROOVE IN THE WARM FLANGE. O-RINGS ARE TO BE PLACED WHERE SHOWN.



Introduction

The expander is the part of the closed cycle cryogenic refrigerator that gets cold. It operates on the principle of the Gifford-McMahon refrigeration cycle. It is connected to a compressor by two gas lines and an electrical power cable. One of the gas lines supplies high pressure helium gas to the expander, the other gas line returns low pressure helium gas from the expander.

The compressor provides the necessary helium gas flow rate at the high and low pressure for the expander to convert into the desired refrigeration capacity. The electrical power from the compressor drives a motor which turns a valve disc inside the expander.

The high pressure helium gas flows into the valve motor housing. The rotary valve alternately opens and closes ports in a valve stem in a precisely timed repetitive cycle. First high pressure gas is admitted into the lower portion of the expander. Then the gas is vented to the low pressure return out of the valve motor base and back to the compressor. Inside the lower portion of the expander is a displacer assembly which reciprocates due to the cyclical changes in gas pressure.

The displacer assembly comprises a slack cap coupled to a 1st stage displacer, and the 1st stage displacer is coupled to a smaller diameter 2nd stage displacer. Each displacer stage contains internal regenerative heat exchangers to exchange heat with the gas to maximize the available refrigeration. Seals on the outside of the displacer assembly rub on the inside of a cylinder to minimize gas leakage between the high and low pressures.

The cylinder assembly provides a mounting flange (the warm flange), an instrumentation skirt (not shown), and two levels of refrigeration (the 1st stage and 2nd stage heat stations). The 2nd stage heat station gets coldest. Tapped holes on each heat station are provided for the customer to attach radiant heat shields and/or sample mounts.

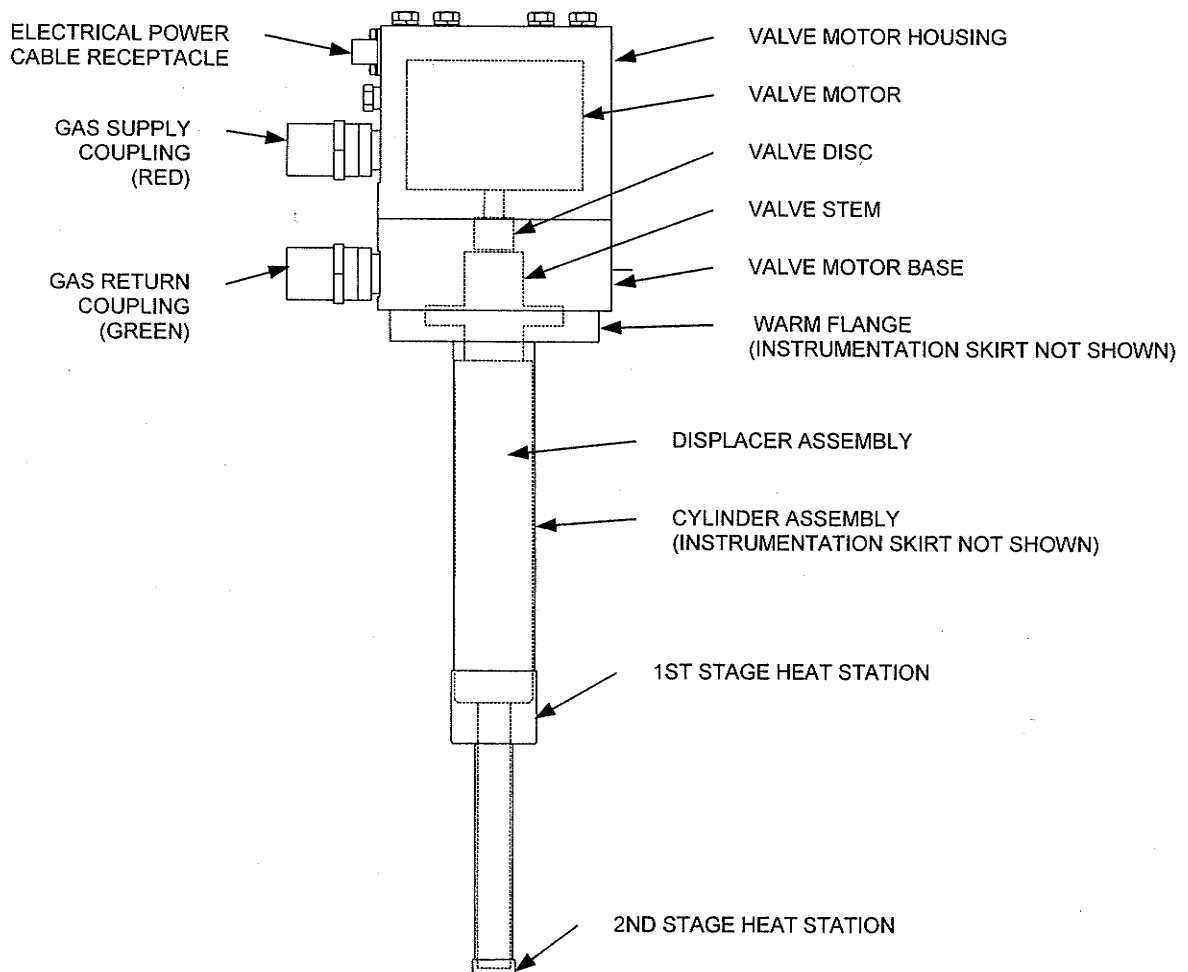



Your expander may have a suffix or suffixes at the end of the model number, e.g. DE202**NB**. The following suffixes are defined:

N = The 2nd stage can achieve a minimum temperature < 6 K.

S = The 2nd stage can achieve a minimum temperature < 4 K.

Non-N and non-S expanders can achieve < 9 K.

Note: All cryostats are tested at ARS Inc. and verified to achieve the advertised minimum temperature at the expander 2nd stage heat station, not at the sample.

B = The cylinder assembly only, with the displacer assembly and valve motor assembly removed, can be heated to 200 C (475 K), or to 400 C (675 K) without instrumentation attached. These expanders have high vacuum "Conflat" flanges on the skirt.

Non-B expanders have o-ring seals on the skirt. These expanders can be safely heated to 80-100 C (355-375 K).

FF = The cylinder assembly has a flat warm flange, without an instrumentation skirt permanently attached.

Non-FF expanders have welded to the warm flange an instrumentation skirt with 3 user feedthrough ports and 1 vacuum pumpout port.

G, K = Special configurations for applications requiring movement of the expander, mounting to the customer's goniometer.



Installation

1. Unpack the equipment and inspect it for shipping damage. The expander, compressor, and gas lines are shipped pressurized with helium gas at the equalization pressure of the compressor.
2. Attach the accessories to the expander (radiant heat shields, sample holders, vacuum shrouds, etc.) in accordance with your application.
3. Secure the expander in position with a method suitable to your application. The expander will function in any orientation.
4. Connect the gas lines to the compressor and expander:

WARNING

ALWAYS WEAR EYE PROTECTION WHEN HANDLING ANY PRESSURIZED EQUIPMENT.

WARNING

NEVER APPLY HEAT TO ANY PRESSURIZED EQUIPMENT.

CAUTION !

Before connecting the gas lines to the compressor or expander, check that the face seal ring on the male coupling is in good condition, and that the faces of both mating couplings are clean.

NOTE

KEEP THE DUST CAPS OR PLUGS ON UNUSED GAS COUPLINGS.

- 4.1. Connect one gas line to the supply gas couplings (red) at the compressor and expander.
- 4.2. Connect the other gas line to the return gas couplings (green) at the compressor and expander.
- 4.3. Use two wrenches (provided with the expander) to hold and turn the gas line coupling (female) where shown. Turn until tight.

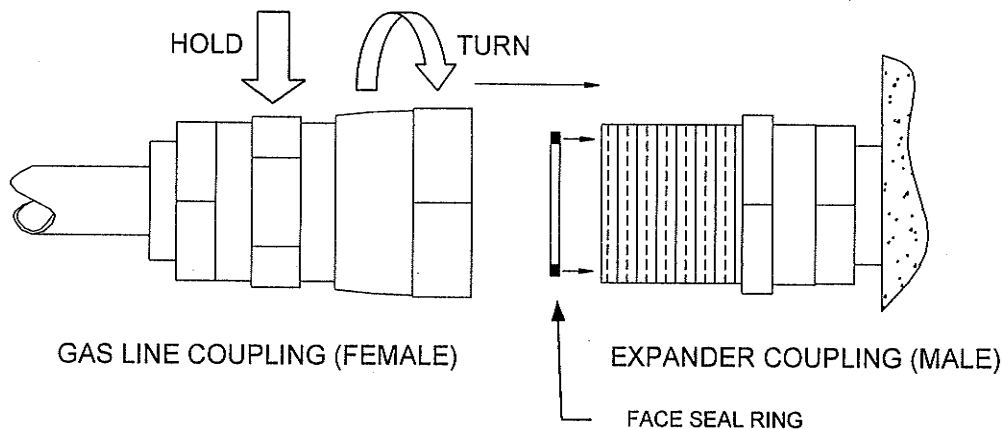



Installation

5. Attach your instrumentation wiring to any connectors provided on the expander skirt in accordance with your application.
6. Connect the expander electrical power cable to the compressor and expander receptacles.
7. Connect the proper electrical power, and if applicable the cooling water supply and drain, to the compressor.

CAUTION !

Verify the electrical supply power frequency matches the frequency on the expander label. The expander is set at the factory for operation at either 50 Hz or 60 Hz.

8. Connect a source of clean vacuum, isolated by a vacuum valve, to the pumpout port provided on the expander skirt.

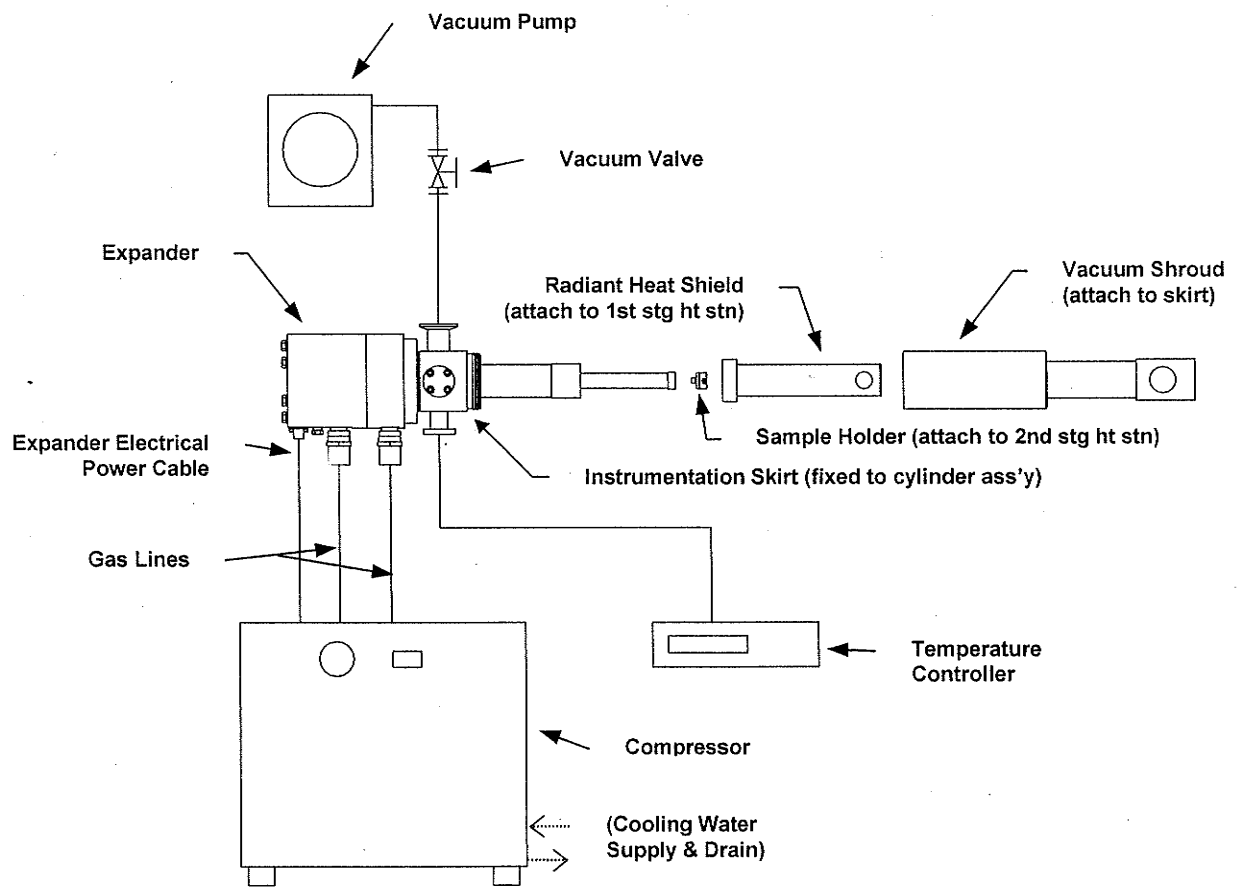



Operation

1. Verify the equalization pressure on the compressor pressure gauge meets the requirement listed on the compressor and/or in the compressor manual. If the pressure is below the minimum, then add helium gas in the manner described in the compressor manual (use only 99.999% ultra-pure helium, dew point < -50 C (-58 F) at 300 psig (2069 kPa)). Attach the regulated helium gas supply cylinder to the fill/vent fitting attached to the expander using tubing and fittings rated for the gas supply pressure.

⚠ WARNING

NEVER USE HELIUM GAS FROM A CYLINDER WITHOUT A PROPER PRESSURE REGULATOR AND PROPERLY RATED TUBING AND FITTINGS.

⚠ WARNING

ALWAYS WEAR EYE PROTECTION WHEN HANDLING ANY PRESSURIZED EQUIPMENT.

2. Evacuate the expander vacuum shroud or enclosure to < 0.1 torr. Lower vacuum pressure, < 1 E-4 torr, is preferred because it reduces the residual heat load on the expander but requires cleaner vacuum pumps (e.g. liquid nitrogen cold traps, turbomolecular pumps, cryopumps).

CAUTION !

Never open the vacuum valve when connected to a vacuum pump that is off.

- 2.1. Close the vacuum valve.
 - 2.2. Turn on the vacuum pump.
 - 2.3. Slowly open the vacuum valve.
 - 2.4. The expander can be started with an insulating vacuum pressure of < 0.1 torr. However, a lower starting pressure is preferred.
3. Turn on the compressor. The expander will begin to cooldown. The noise from the expander should be a regular beat at a frequency approximately 2X the frequency of the electrical supply power.

NOTE

THE EXPANDER MAY BE NOISY DURING COOLDOWN, BUT THE NOISE LEVEL WILL DECREASE TO A NORMAL MINIMUM AS IT REACHES THE COOLDOWN TEMPERATURE.

4. Close the vacuum valve when the vacuum pressure remains < 0.01 torr or the expander has cooled to 150 - 200 K.
5. The cooldown time and minimum temperature achieved will depend upon your application (sample material, size, mass, heat loads).
6. To stop operation, turn off the compressor.



Removal

1. Turn off the compressor and wait until the expander 2nd stage has warmed to $> 273 \text{ K}$ (0 C).
2. Break the insulating vacuum in the vacuum shroud or enclosure, and disconnect the vacuum plumbing from the expander.

NOTE

IT IS PREFERRABLE TO BREAK VACUUM WITH DRY GAS TO MINIMIZE ACCUMULATION OF MOISTURE IN THE VACUUM SPACE. IF THE INSULATING VACUUM IS BROKEN WHEN THE EXPANDER IS COLD, THE OUTSIDE OF THE VACUUM ENCLOSURE WILL FROST OR BECOME WET.

⚠ WARNING

WHEN BREAKING A VACUUM WITH GAS, DO NOT EXCEED ATMOSPHERIC PRESSURE.

CAUTION !

Never open the vacuum valve when connected to a vacuum pump that is off.

3. Disconnect the electrical power cable.
4. Disconnect any instrumentation cables from the expander.
5. Disconnect the gas lines from the expander:

⚠ WARNING

ALLOW THE EXPANDER TO WARM TO ROOM TEMPERATURE BEFORE DISCONNECTING THE GAS LINES. COLD GAS, IF TRAPPED IN THE EXPANDER, CAN REACH DANGEROUSLY HIGH PRESSURE IF ALLOWED TO WARM.

⚠ WARNING

NEVER APPLY HEAT TO ANY PRESSURIZED EQUIPMENT.

⚠ WARNING

USE 2 WRENCHES TO DISCONNECT GAS LINES FROM THE EXPANDER TO AVOID LOOSENING THE EXPANDER COUPLING.

⚠ WARNING

ALWAYS WEAR EYE PROTECTION WHEN HANDLING ANY PRESSURIZED EQUIPMENT.



NOTE
KEEP THE DUST CAPS OR PLUGS ON UNUSED GAS COUPLINGS.

5.1. Use 2 wrenches (provided with the expander) to hold and turn the gas couplings where shown:

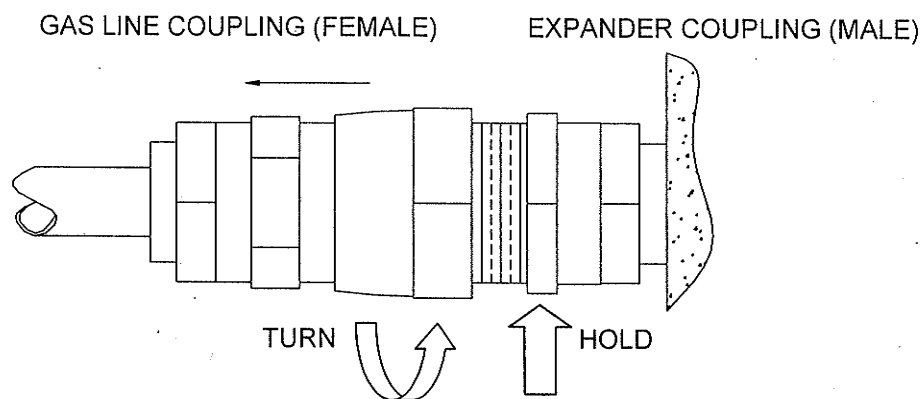

6. Remove the expander from the application mounting.



Maintenance

The expander normally requires no maintenance until it has been operated for 10,000 hours. By that time the valve disc, valve stem, and displacer seals will have typically worn enough to need repair. However, depending on the performance you need this maintenance interval can be extended without damaging the expander.

Also check the compressor manual for any compressor service; some compressors require an adsorber change at 10,000 hours.

Contact ARS Inc. for parts, tools, service, or any questions you have concerning the use or maintenance of this equipment. When ordering parts or tools, you must supply the model number and serial number (M/N and S/N) of the expander as marked on the nameplate affixed to the end face of the valve motor assembly. Contact:

Advanced Research Systems, Inc.

Suite 109

905 Harrison Street

Allentown, PA 18103 USA

tel: 610 439 8022

fax: 610 439 1184

email: ars@arscryo.com

service email: arsservice@arscryo.com

web: www.arscryo.com

The expander is designed to operate safely with only original ARS Inc. parts and when the installation and servicing are performed in accordance with the instructions in this manual.

If you choose to perform the service yourself, follow these instructions, steps 1 thru 19:

NOTE

YOU NEED BOTH THE SERVICE TOOL KIT AND THE MAINTENANCE KIT FOR THE SPECIFIC EXPANDER BEFORE DISASSEMBLING IT FOR MAINTENANCE. YOU WILL ALSO NEED A PRECISION SURFACE PLATE, A 0-1 in (0-25 mm) MICROMETER, AND MASKING TAPE TO PROPERLY DRESS THE DISPLACER 2ND STAGE SEALS.

1. Vent the gas from the expander:

NOTE

DO NOT DISASSEMBLE THE EXPANDER UNLESS THE PROPER HELIUM GAS AND RE-FILLING EQUIPMENT ARE AVAILABLE. USE ONLY 99.999% ULTRA-PURE HELIUM GAS WITH A DEW POINT LESS THAN -50 C (-58 F) AT 300 PSIG (2069 kPa).



NOTE

USE 2 FILL/VENT FITTINGS, P/N 001075, WITH 1 EACH ATTACHED TO THE SUPPLY (RED) AND RETURN (GREEN) GAS COUPLINGS ON THE EXPANDER.

1.1. Connect fill/vent fittings from the service tool kit to the expander gas supply and return couplings (red and green). Refer to Installation step 4.3 on page 7 for instructions on connecting gas couplings.

1.2. Slowly open the valves on the fill/vent fittings and vent the gas to atmospheric pressure.

2. Remove the valve motor assembly:

WARNING

BEFORE REMOVING THE VALVE MOTOR HOUSING BOLTS ON THE EXPANDER IN ORDER TO PERFORM MAINTENANCE, VENT ALL GAS FROM THE EXPANDER FROM BOTH THE SUPPLY (RED) AND RETURN (GREEN) COUPLINGS.

2.1. Loosen and remove all 8 bolts from atop the valve motor housing.

2.2. Lift the valve motor assembly straight up out of the cylinder assembly.

2.3. Cover the open cylinder assembly to protect the displacer assembly inside it.

CAUTION !

Do not get contaminants (particulates, moisture, oils or solvents, etc.) inside the expander.

NOTE

PERFORM THE FOLLOWING SERVICE WITHIN 3 HOURS. THE DISPLACER ASSEMBLY IS SENSITIVE TO HUMIDITY. LONGER EXPOSURE WOULD REQUIRE IT TO BE VACUUM BAKED > 12 HOURS @ 80 C AND < 1 torr TO DRY IT.

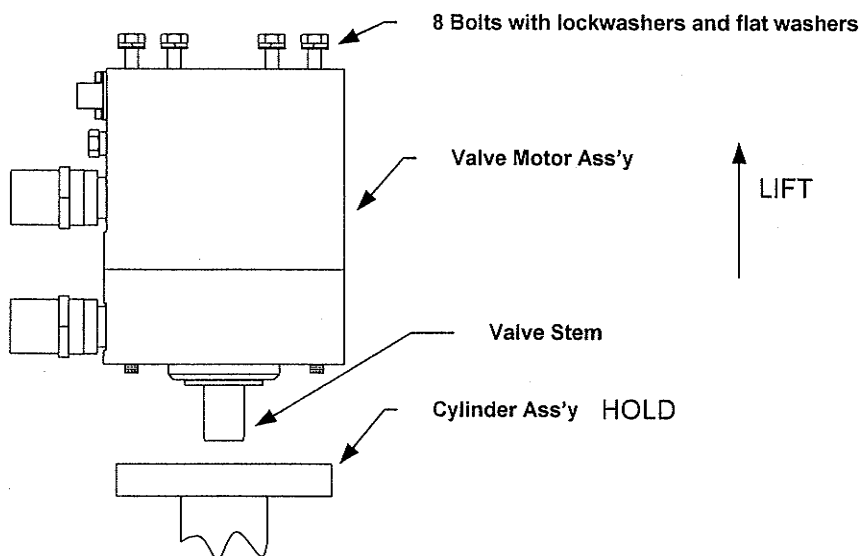



Maintenance

3. Remove the valve stem from the valve motor assembly.

- 3.1. Pull and twist the valve stem to remove it; or,

Pry it out using 2 gas coupling wrenches (provided with the expander) or screwdrivers, placing their handles under the valve stem 180° apart. Do not damage the o-ring sealing surface.

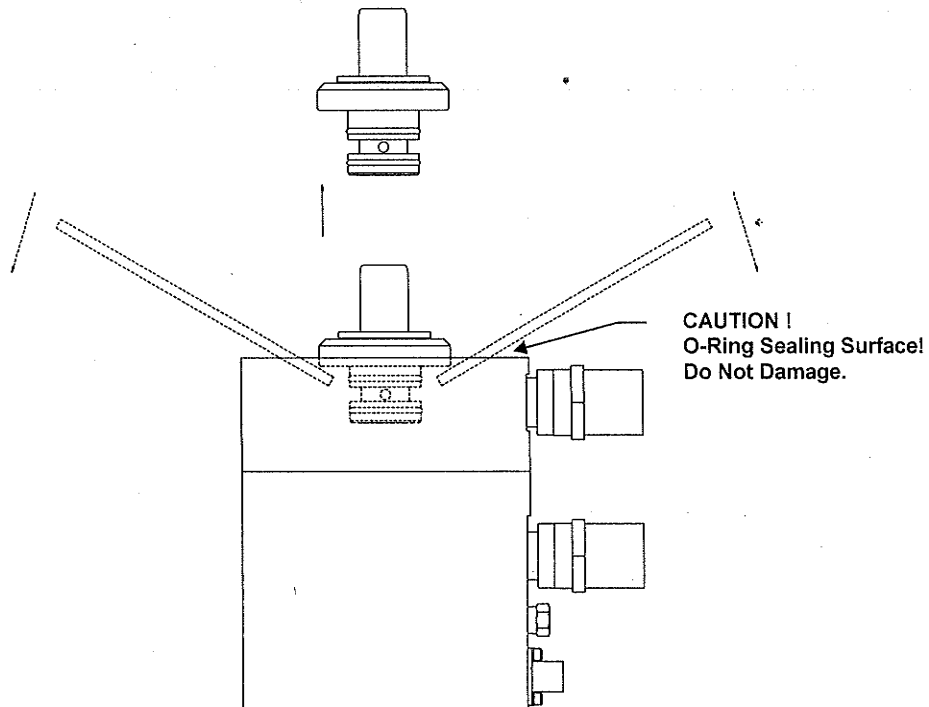

4. Remove the valve disc by orienting the valve motor assembly open end down, and shaking to let the valve disc drop off of the valve motor shaft.

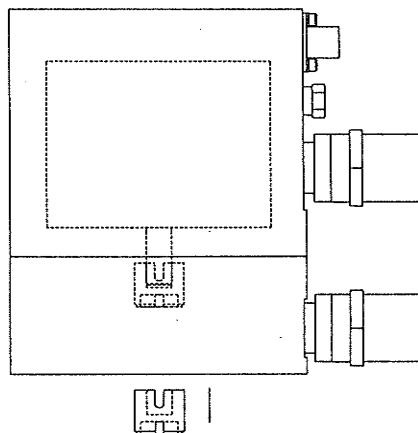



5. Install the new valve disc and valve stem:

CAUTION !
Do not damage, and keep clean, the mating surfaces between the valve disc and valve stem.

CAUTION !
Do not apply any lubricant to the valve disc.

CAUTION !
Do not install a dirty or blemished valve disc or valve stem in the expander.

NOTE
WEAR CLEAN LINTLESS GLOVES. KEEP PARTS, WORK AREA, AND TOOLS CLEAN.

- 5.1. Carefully install the valve disc onto the valve motor shaft, turning it to align the slots on the valve disc with the roll pin on the valve motor shaft.
- 5.2. Push down on the valve disc and release it a few times to verify it's in contact with the spring and moves freely.
- 5.3. Carefully insert the valve stem into the valve motor assembly until fully seated.
- 5.3.1. Align model 202 valve stem with orifice near "gas coupling side" of valve motor assembly.
- 5.3.2. Align model 204 valve stem with clearance notch over the protruding brass fitting in valve motor assembly.

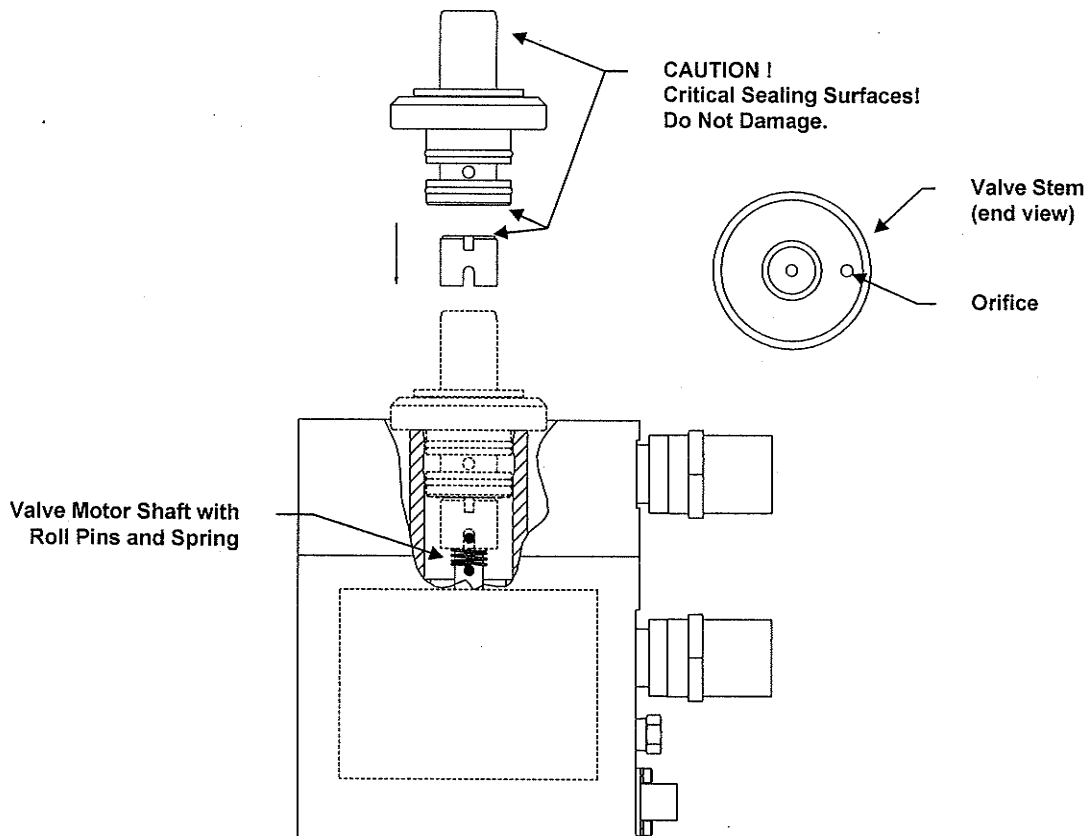



6. Cover the valve motor assembly to keep it clean.
7. Carefully pull the displacer assembly straight up and out of the cylinder assembly.
 - 7.1. Use the displacer puller (L-shaped rod) from the service tool kit. Screw it into the mating hole atop the displacer assembly.

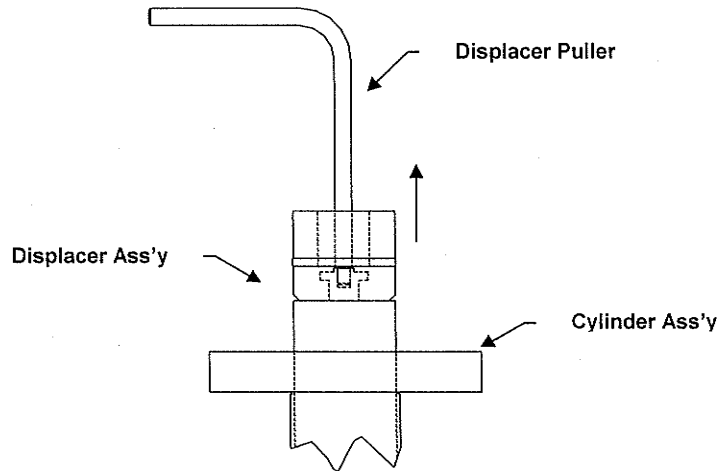

8. Carefully remove the displacer seals and backing o-ring/spring from the inside of the slack cap, the outside of the slack cap, the outside of the 1st stage, and the outside of the 2nd stage.

CAUTION !

Do not use any solvents or greases on the displacer assembly, seals, or seal o-rings.

- 8.1. Each seal is comprised of 2 slit rings and a backing o-ring (a backing garter spring on the 2nd stage).
- 8.2. To remove each seal slit ring, find the slit and spread apart the seal using a sharp tweezers or toothpick.
- 8.3. Do not damage the seal grooves.

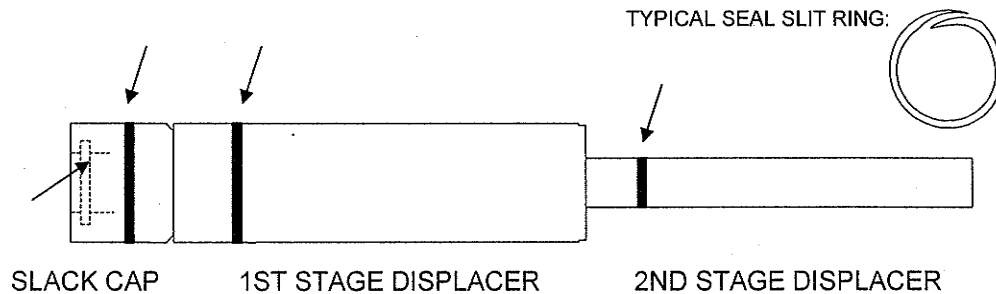



Maintenance

9. Install the new seals (new backing o-rings/spring and new slit rings) per the following instructions:

CAUTION !

Do not apply any lubricant to the displacer seals or seal o-rings.

CAUTION !

Do not substitute the o-rings used on the displacer seals. Use only factory-supplied o-rings. They are a special compound and durometer.

NOTE

WEAR CLEAN LINTLESS GLOVES. KEEP PARTS, WORK AREA, AND TOOLS CLEAN.

NOTE

YOU NEED BOTH THE SERVICE TOOL KIT AND THE MAINTENANCE KIT FOR THE SPECIFIC EXPANDER FOR THIS MAINTENANCE. YOU WILL ALSO NEED A PRECISION SURFACE PLATE, A 0-1 in (0-25 mm) MICROMETER, AND MASKING TAPE TO PROPERLY DRESS THE 2nd STAGE SEALS.

- 9.1. Gather the following tools from the service tool kit:

- Seal Lapping Tool and Pin
- 2nd Stage Seal Seating Tool
- Slack Cap Seal Seating Tool
- Sheet of 600 Grit Abrasive Paper

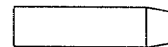
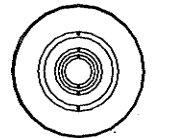

- 9.2. The 2nd stage seal slit rings must be lapped flat with parallel faces to fit properly in the mating displacer groove.
- 9.3. The 1st stage and slack cap seal slit rings are already sized for installation, but may require a light lapping for flatness and parallelism. Measure them first; see step 9.12.
- 9.4. To lap a seal slit ring, first wipe off any loose material from the ring and fit it into the appropriate groove in the seal lapping tool.
- 9.5. Seat the ring in the tool by carefully pressing the tool, ring side down, onto the surface plate.



Maintenance

- 9.6. Firmly tape the sheet of abrasive paper along all four edges flat on the surface plate. The new paper is very abrasive to the soft seal ring material. Pre-condition the paper by first lapping lightly with an old valve disc; then blow off the dust.
- 9.7. Hold only the outside diameter of the seal lapping tool with your finger tips.
- 9.8. Use a very gentle full figure 8 motion to lap material from the seal ring face. Do not press down or tilt the tool.
- 9.9. Remove the least amount of material necessary until the surface gloss on the seal ring face is uniform without any high spots.
- 9.10. Release the seal ring from the lapping tool by carefully pushing it out with the pin provided in the tool kit, pushing the pin through the holes from the back side of the tool.
- 9.11. Reverse the seal ring, re-install it in the lapping tool, and lap the opposite face in the same manner.
- 9.12. Measure the seal ring thickness at 3 places (each approximately 120° apart around the seal circumference) with a micrometer:

1ST STAGE & SLACK CAP SEAL RINGS:

ALL THICKNESS MEASUREMENTS MUST BE WITHIN 0.0003 in (8 μ m) OF EACH OTHER.

MIN. THICKNESS FOR ONE SEAL RING = 0.057 in (1.45 mm)

THICKNESS OF COMBINED PAIR = 0.116 - 0.118 in (2.95 - 3.00 mm) AND THE INSTALLED SEAL RINGS WILL SLIP IN THE GROOVE BUT NOT BIND OR DISTORT.

2ND STAGE SEAL RINGS:

ALL THICKNESS MEASUREMENTS MUST BE WITHIN 0.0002 (5 μ m) OF EACH OTHER.

MIN. THICKNESS FOR ONE SEAL RING = 0.055 in (1.40 mm)

THICKNESS OF COMBINED PAIR = SEE FIT-BY-FEEL PROCEDURE BELOW;
APPROXIMATELY 0.111 in (2.82 mm).

2ND STAGE SEAL FIT-BY-FEEL PROCEDURE:

COMBINE THE SEAL RING PAIR, ORIENTED CORRECTLY AS SHOWN (SLITS 180° APART AND BOTH CURVING IN THE SAME DIRECTION).

INSERT THE EDGE OF THE SEAL RING PAIR INTO THE 2ND STAGE GROOVE.

TRY TO ROLL THE PAIR AROUND THE GROOVE. THE FIT SHOULD BE SNUG ENOUGH TO PROMOTE ROLLING, NOT SLIDING, AND WITHOUT DISTORTION.

SEAL RING PAIR SLIT ORIENTATION:

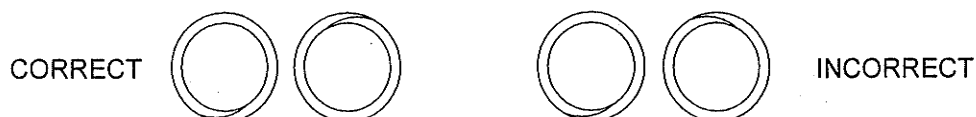



Maintenance

- 9.13. Install the seal o-rings (a garter spring on the 2nd stage) into the appropriate grooves.
- 9.13.1. Do not roll, twist, or over-stretch the o-rings or spring.
 - 9.13.2. Do not apply any grease to the o-rings or spring.
 - 9.13.3. Do not substitute the o-rings or spring used on the displacer seals. Use only factory-supplied o-rings; they are a special compound and durometer.
- 9.14. Install the seal ring pairs into the appropriate grooves, oriented correctly as shown (SLITS 180° APART, BOTH CURVING IN THE SAME DIRECTION, AND ON THE 2ND STAGE RELATIVE TO THE SLANT OF THE SPRING COILS).

2ND STAGE SEAL RING SLIT AND SPRING COIL SLANT ORIENTATION:

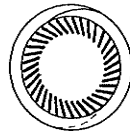

CORRECT

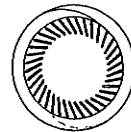

INCORRECT

- 9.14.1. Do not over-stretch the slit rings.
 - 9.14.2. Check the fit-by-feel if necessary:
 - THE 1ST STAGE & SLACK CAP SEAL SLIT RING PAIRS WILL SLIP AND NOT BIND OR DISTORT.
 - THE 2ND STAGE SEAL SLIT RING PAIR WILL BE SNUG AND WILL NOT SLIDE NOR DISTORT.
- 9.15. Seat the inner slack cap seal by carefully inserting the slack cap seal seating tool, tapered end first, into the slack cap. Do not twist the tool. Then remove the tool; do not twist.
- 9.15.1. Check that the seal sets squarely and is not distorted.
 - 9.15.2. REPEAT 2X MORE.
- 9.16. Seat the 2nd stage seal by carefully sliding the 2nd stage seal seating tool, tapered end first, over the 2nd stage displacer. Do not twist the tool. Then remove the tool; do not twist.
- 9.16.1. Check that the seal does not unseat, spring out.
 - 9.16.2. REPEAT 4X MORE.
 - 9.16.3. IF THE SEAL REPEATEDLY UNSEATS, SPRINGS OUT, THEN REPLACE ONE SEAL SLIT RING WITH A NEW ONE THAT IS LAPPED TO FIT TIGHTER.

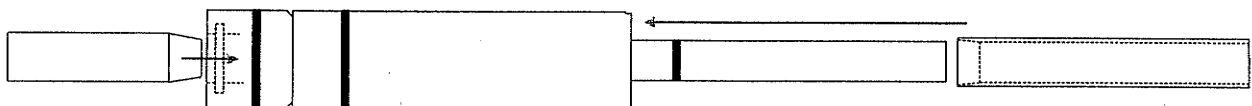



Maintenance

10. If the preceding steps 2 through 9 were performed within 3 hours, then go to step 11. Otherwise:
 - 10.1. Vacuum bake the displacer assembly in a clean, dry, oil-free vacuum oven for > 12 hours @ 80 C and < 1 torr.
 - 10.2. Repeat step 9.16 to verify the 2nd stage seal remains seated after being vacuum baked.

11. If the displacer assembly will be promptly installed into the cylinder assembly, then go to step 12. Otherwise:
 - 11.1. Store the displacer assembly inside 2 sealed plastic bags, each back-filled with dry gas (nitrogen or helium). This will keep the displacer assembly dry for a few days. If stored longer, then repeat steps 10.1 and 10.2 before proceeding to step 12.

12. Carefully insert the displacer assembly straight down into the cylinder assembly until it bottoms.

CAUTION !

Do not get contaminants (particulates, moisture, oils or solvents, etc.) inside the expander.

- 12.1. Screw the displacer puller into the mating hole atop the displacer assembly (ref. illustration at Maintenance step 7.1, page 16).
 - 12.2. Raise and lower and jiggle the displacer assembly to get the 2nd stage displacer to enter the 2nd stage cylinder.
 - 12.3. A force of 10-20 lb (5-9 kg) for the DE202 displacer assembly [15-30 lb (7-14 kg) for the DE204] is required to install the displacer assembly until it bottoms in the cylinder assembly.
-
13. Remove the puller.
 14. Repeat step 9.15 to seat the inner slack cap seal.
 15. Verify both the warm flange o-rings are in good condition and installed in the proper grooves.

NOTE

DO NOT FIT AN O-RING INTO THE WELD RELIEF GROOVE IN THE WARM FLANGE. O-RINGS ARE TO BE PLACED WHERE SHOWN.

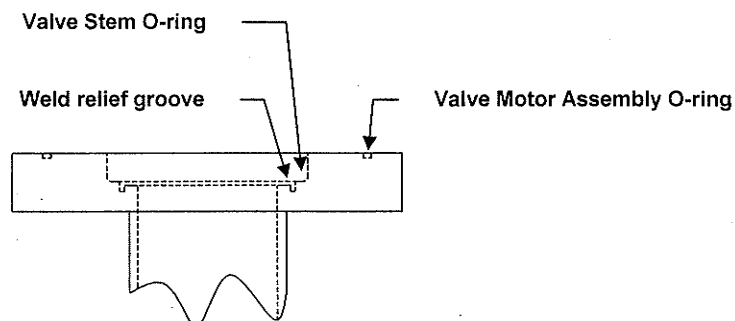



Maintenance

16. Carefully install the valve motor assembly straight down into the cylinder assembly, inserting the valve stem into the slack cap (ref. illustration at Maintenance step 2, page 13).
17. Install all 8 bolts with lockwashers and flat washers from atop the valve motor housing. Torque all in a criss-cross manner to 120-160 lb-in (14-18 N-m).
18. Fill the expander with helium gas (use only 99.999% ultra-pure helium, dew point < -50 C (-58 F) at 300 psig (2069 kPa)) to the equalization pressure defined on the compressor and/or in the compressor manual, and per the following:

⚠ WARNING

NEVER USE HELIUM GAS FROM A CYLINDER WITHOUT A PROPER PRESSURE REGULATOR AND PROPERLY RATED TUBING AND FITTINGS.

⚠ WARNING

ALWAYS WEAR EYE PROTECTION WHEN HANDLING ANY PRESSURIZED EQUIPMENT.

CAUTION !

Before connecting the gas fittings to the expander, check that the face seal ring on the male coupling is in good condition, and that the faces of both mating couplings are clean.

NOTE

KEEP THE DUST CAPS OR PLUGS ON UNUSED GAS COUPLINGS.

NOTE

USE 2 FILL/VENT FITTINGS, P/N 001075, WITH 1 EACH ATTACHED TO THE SUPPLY (RED) AND RETURN (GREEN) GAS COUPLINGS ON THE EXPANDER.

- 18.1. Connect fill/vent fittings from the service tool kit to the expander gas supply and return couplings (red and green). Refer to Installation step 4.3 on page 7 for instructions on connecting gas couplings.
- 18.2. Connect the expander electrical power cable to the compressor and expander receptacles.
- 18.3. Attach the regulated helium gas supply cylinder to the fill fitting attached to the gas supply (red) coupling on the expander using tubing and fittings rated for the gas supply pressure. Use only 99.999% ultra-pure helium with a dew point less than -50 C (-58 F) at 300 psig (2069 kPa).
- 18.4. Set the helium supply pressure at 100 psig (690 kPa).



Maintenance

- 18.5. Turn on the compressor to power the valve motor and valve disc.
- 18.6. Open the helium supply valves on the cylinder, regulator, and both the fill/vent fittings attached to the gas supply and return (red and green) couplings on the expander. Gas will begin to vent out of the return-side vent fitting in a pulsating manner because the valve is alternately admitting/venting gas.
- 18.7. Wait 5 seconds, then close the helium gas supply cylinder valve (not the regulator).
- 18.8. Watch the regulator pressure gauge. Wait until the pressure decreases to 5-10 psig (30-70 kPa). Then re-open the helium gas supply cylinder valve.
- 18.9. REPEAT STEPS 18.7 and 18.8 9X MORE.
- 18.10. Close the valve on the vent fitting on the gas return (green) coupling on the expander.
- 18.11. Increase the setting on the helium supply pressure regulator to the equalization pressure defined on the compressor and/or in the compressor manual. Wait 10 seconds.
- 18.12. Turn off the compressor.
- 18.13. Disconnect the helium gas supply and both fill/vent fittings from the expander. Refer to Removal step 5.1 on page 11 for instructions on disconnecting gas couplings.

⚠ WARNING

USE 2 WRENCHES TO DISCONNECT GAS LINES FROM THE EXPANDER TO AVOID LOOSENING THE EXPANDER COUPLING.

⚠ WARNING

ALWAYS WEAR EYE PROTECTION WHEN HANDLING ANY PRESSURIZED EQUIPMENT.

NOTE

KEEP THE DUST CAPS OR PLUGS ON UNUSED GAS COUPLINGS.

19. Re-install and operate the expander. Refer to Installation and Operation sections, pages 7 through 9.



Troubleshooting

The following troubleshooting guide lists the most common problems that can occur. Also check the compressor manual.

⚠ WARNING

PERMIT ONLY QUALIFIED ELECTRICAL TECHNICIANS TO OPEN ELECTRICAL ENCLOSURES, OR TO PERFORM TESTS WITH THE POWER SUPPLY CONNECTED AND WIRING EXPOSED.

Problem	Possible Cause(s)	Corrective Action(s)
1. No cooldown - Valve motor does not start when compressor starts	1.1 Expander electrical power cable not connected 1.2 Open circuit in cable 1.3 Defective valve motor 1.4 Blown fuse or tripped circuit breaker in compressor	1.1 Connect the cable; See Installation section of this manual 1.2 Disconnect cable; Check continuity of each wire, and each plug and receptacle pin; Repair/replace cable as necessary 1.3 Check motor for shorts to ground; Check motor for winding resistance (A-B \approx 2 k Ω , A-C & B-C \approx 1 k Ω); See wiring schematic at end of this table
2. No cooldown - Valve motor hums but does not start	2.1 Defective capacitor or resistor 2.2 Defective valve motor 2.3 Open circuit in cable	2.1 Check/replace valve motor capacitor and/or resistor in compressor; See wiring schematic at end of this table 2.2 See 1.3 2.3 See 1.2
3. No cooldown - Valve motor runs	3.1 No or poor insulating vacuum 3.2 Gas line couplings are not fully connected, or are connected wrong 3.3 Compressor gas flow rate inadequate	3.1 Check vacuum system operation and pressure (must be < 1 E-3 torr); Check for vacuum leaks; See Installation and Operation sections of this manual 3.2 Check that gas lines are properly connected between compressor and expander, supply-supply and return-return; Check that couplings are fully engaged at both ends; See Installation section of this manual 3.3 Check compressor operating pressures; See compressor manual



Troubleshooting

Troubleshooting guide continued -

Problem	Possible Cause(s)	Corrective Action(s)
4. Vacuum shroud or enclosure very cold or "sweating"	4. No or poor insulating vacuum	See 3.1
5. Abnormally noisy operation after 15 minutes of cooldown	5.1 Incorrect compressor pressures 5.2 Contaminants in gas 5.3 Electrical power supply frequency incorrect for expander	5.1 See 3.3 5.2 Vent and re-fill gas in entire system (compressor, gas lines, expander); See Maintenance step 18 in this manual; See compressor manual 5.3 Check expander label for required frequency; Check power supply frequency
6. Intermittent on/off operation	6.1 Compressor cycling on/off 6.2 Compressor cooling water not on 6.3 Compressor oil too cold due to cooling water or ambient temperature	6.1 See compressor manual 6.2 Turn on cooling water; See Installation section of this manual 6.3 Decrease water flow rate or increase water temperature; Place compressor in room warmer than 60 F
7. Expander 2nd stage heat station temperature cycling several degrees ($> \pm 3$ K)	7. Contaminants in gas	7. See 5.2
8. Sudden loss of refrigeration capacity	8.1 Loss of insulating vacuum 8.2 Compressor malfunction 8.3 Defective valve motor 8.4 Defective capacitor or resistor	8.1 See 3.1 8.2 See 6.1 8.3 See 1.3 8.4 See 2.1
9. Slow loss of refrigeration	9.1 Small insulating vacuum leak 9.2 Worn displacer seals 9.3 Small expander helium leak	9.1 See 3.1 9.2 See Maintenance section of this manual; A leaking seal will show intermittent streaks of black on the displacer near the seal. 9.3 Check compressor pressure gauge for loss of pressure; Leak check expander at locations noted in diagram at end of this table using a mass spectrometer helium leak detector probe, or a commercial leak detection solution (dilute soap solution)



Troubleshooting

Troubleshooting guide continued -

Problem	Possible Cause(s)	Corrective Action(s)
<p>10. Sample temperature too high</p> <p>Note: All cryostats are tested at ARS Inc. and verified to achieve the advertised minimum temperature at the expander 2nd stage heat station, not at the sample.</p>	<p>10.1 Thermometry problems: Sensor wires not thermally anchored; Sensor not thermally anchored; Sensor wires shorted; Thermocouples not electrically isolated; Heater introducing some heat</p> <p>10.2 Small insulating vacuum leak</p> <p>10.3 High radiant heat load on sample</p> <p>10.4 High conductive heat load on sample</p> <p>10.5 Sample not thermally anchored</p>	<p>10.1 Securely anchor sensor wires to cold tip; Securely anchor sensor; Check wire insulation; Check for thermal grease shorting exposed sensor or wire contacts; Electrically isolate multiple thermocouple junctions that are attached to the same metal; Reduce applied heater power or unplug heater</p> <p>10.2 See 3.1</p> <p>10.3 Close radiant heat shield openings with aluminum foil; Reduce or shield laser or glowing heat sources;</p> <p>10.4 Minimize heat paths to sample (e.g. minimize quantity and diameter of wires, maximize their length).</p> <p>10.5 Securely anchor sample to mount and mount to expander 2nd stage heat station; Use indium foil or wire between metal-metal contacts; Choose higher conductivity windows (e.g. sapphire); Use thermal "Cry-Con" grease or silver-filled epoxy between sample and window contacts, but minimize thickness of grease or epoxy layer</p>



Troubleshooting

VALVE MOTOR WIRING SCHEMATIC (MOTOR SHAFT ROTATES CLOCK-WISE WHEN FACING SHAFT)

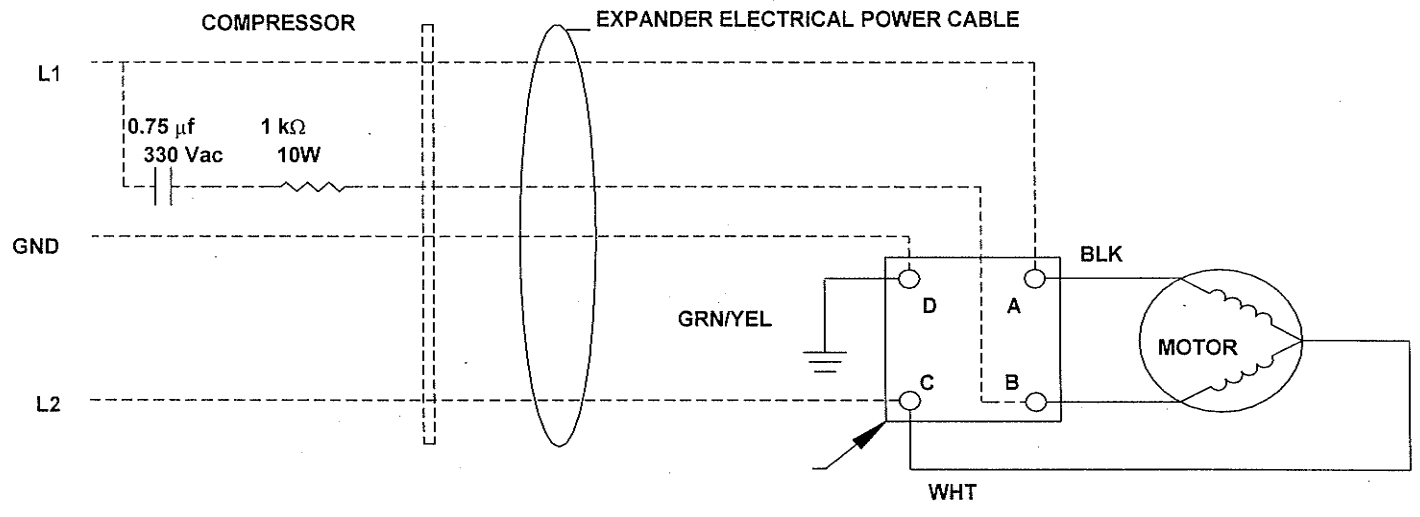

Expander Leak Check Locations -

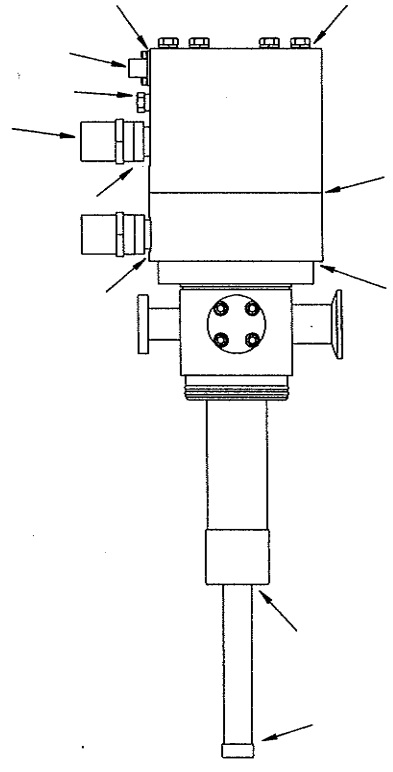



Advanced Research Systems, Inc.

Parts

Contact ARS Inc. for parts, tools, service, or any questions you have concerning the use or maintenance of this equipment. When ordering parts or tools, you must supply the model number and serial number (M/N and S/N) of the expander as marked on the nameplate affixed to the end face of the valve motor assembly. Contact:

Advanced Research Systems, Inc.

Suite 109

905 Harrison Street

Allentown, PA 18103 USA

tel: 610 439 8022

fax: 610 439 1184

email: ars@arscryo.com

service email: arsservice@arscryo.com

web: www.arscryo.com

The expander is designed to operate safely with only original ARS Inc. parts and when the installation and servicing are performed in accordance with the instructions in this manual.

EXPANDER INSTALLATION TOOL KIT (provided with new expander) –

QTY	ARS P/ N	DESCRIPTION
1		1" THIN HEAD SERVICE WRENCH
1		1 ¹ / ₈ " THIN HEAD SERVICE WRENCH
1		1 ³ / ₁₆ " THIN HEAD SERVICE WRENCH

Typical Service Wrench

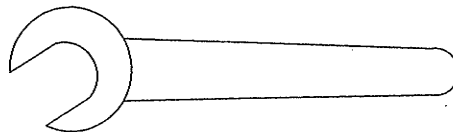

FILL/VENT FITTING, ARS P/N 001075 –

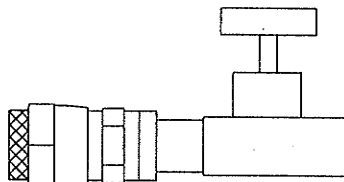



DE202 SERVICE TOOL KIT -

QTY	ARS P/N	DESCRIPTION
1	001067	SEAL LAPPING TOOL
1		PIN, Ø 0.043
1		SHEET, 600 GRIT SILICON CARBIDE ABRASIVE PAPER
1	001069	2ND STAGE SEAL SEATING TOOL
1	001071	SLACK CAP SEAL SEATING TOOL
1	001073	DISPLACER PULLER
2	001075	FILL/VENT FITTING

DE204 SERVICE TOOL KIT -

QTY	ARS P/N	DESCRIPTION
1	001068	SEAL LAPPING TOOL
1		PIN, Ø 0.060
1		SHEET, 600 GRIT SILICON CARBIDE ABRASIVE PAPER
1	001070	2ND STAGE SEAL SEATING TOOL
1	001072	SLACK CAP SEAL SEATING TOOL
1	001074	DISPLACER PULLER
2	001075	FILL/VENT FITTING

Seal Lapping Tool and Pin

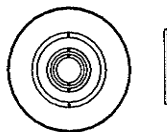

Fill/Vent Fitting

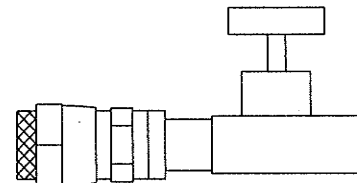

2nd Stage Seal Seating Tool



Slack Cap Seal Seating Tool



Displacer Puller

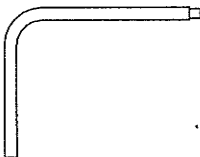



DE202 10,000 hr MAINTENANCE KIT -

QTY	ARS P/N	DESCRIPTION
1	000269-2	ORING, VALVE MOTOR BASE TO WARM FLANGE
1	000269-3	ORING, VALVE STEM TO WARM FLANGE
1	000257	VALVE DISC
2	990132	SLACK CAP INNER SEAL RING, SLIT
1	990129-2	SLACK CAP INNER SEAL O-RING
4	990127	1ST STAGE SEAL RING, SLIT
2	990129-1	1ST STAGE SEAL O-RING
3	990130	2ND STAGE SEAL RING, SLIT
1	990131	2ND STAGE SEAL SPRING
1		VALVE STEM ASS'Y:
	1 000258	VALVE STEM
	2 000269-4	O-RING, VALVE STEM, UPPER
	1 000259	WARM BUMPER
	1 000260	STEM BUMPER
	1 000261	202 ORIFICE, 60 Hz
	(1) (000223)	(202 ORIFICE, 50 Hz)
	1 000262	202/204 EQUALIZATION FLOW RESTRICTOR

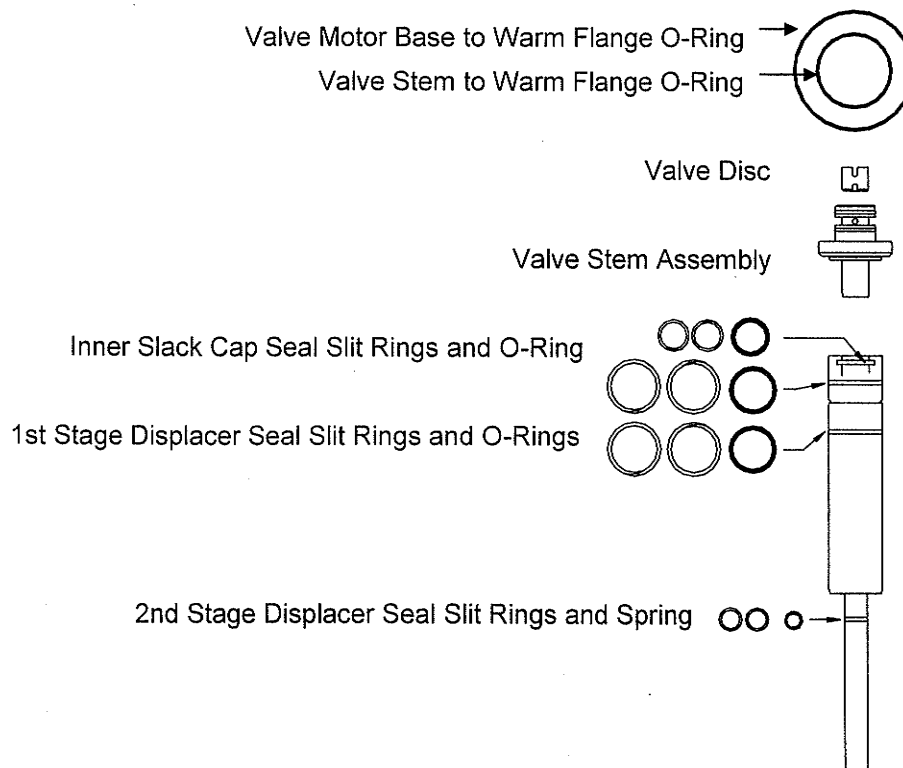



DE204 10,000 hr MAINTENANCE KIT (CALL ARS FOR DE204S KIT)-

QTY	ARS P/N	DESCRIPTION
1	000269-2	ORING, VALVE MOTOR BASE TO WARM FLANGE
1	000269-6	ORING, VALVE STEM TO WARM FLANGE
1	001009	VALVE DISC
2	001007	SLACK CAP INNER SEAL RING, SLIT
1	990129-4	SLACK CAP INNER SEAL O-RING
4	001006	1ST STAGE SEAL RING, SLIT
2	990129-3	1ST STAGE SEAL O-RING
3	001008	2ND STAGE SEAL RING, SLIT
1	001002	2ND STAGE SEAL SPRING
1		VALVE STEM ASS'Y:
	1 000322	VALVE STEM
	2 000269-4	O-RING, VALVE STEM, UPPER
	1 000324	STEM BUMPER
	1 001003	204 ORIFICE, 60 Hz
	(1) (001004)	(204 ORIFICE, 50 Hz)
	1 000262	202/204 EQUALIZATION FLOW RESTRICTOR

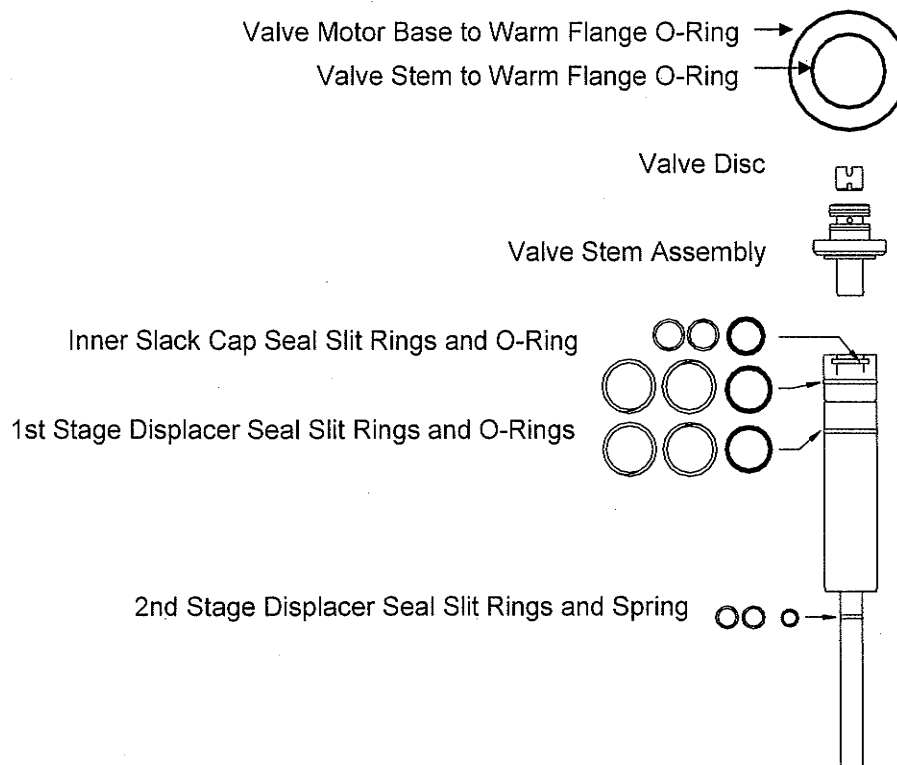

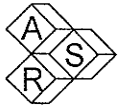

DISPLACER ASSEMBLIES (complete with all seals) –

ARS P/N	DESCRIPTION
990160	DE202
990163	DE202N
000265	DE204
001012	DE204N
021013	DE204S

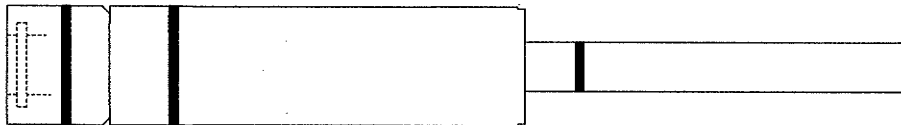

DE202 DISPLACER SEAL RING KITS –

QTY	ARS P/N	DESCRIPTION
2	990132	SLACK CAP INNER SEAL RING, SLIT
1	990129-2	SLACK CAP INNER SEAL O-RING
4	990127	1ST STAGE SEAL RING, SLIT
2	990129-1	1ST STAGE SEAL O-RING
3	990130	2ND STAGE SEAL RING, SLIT
1	990131	2ND STAGE SEAL SPRING

DE204 DISPLACER SEAL RING KITS (CALL ARS FOR DE204S KIT)–

QTY	ARS P/N	DESCRIPTION
2	001007	SLACK CAP INNER SEAL RING, SLIT
1	990129-4	SLACK CAP INNER SEAL O-RING
4	001006	1ST STAGE SEAL RING, SLIT
2	990129-3	1ST STAGE SEAL O-RING
3	001008	2ND STAGE SEAL RING, SLIT
1	001002	2ND STAGE SEAL SPRING

