

The Next Linear Collider and the Origin of Electroweak Physics

Jim Brau
OSU Physics Department Colloquium
May 6, 2002

The Next Linear Collider and the Origin of Electroweak Physics

- What is the Next Linear Collider?
- Electroweak Physics
 - Development
 - unification of E&M with beta decay (weak interaction)
 - Predictions
 - eg. M_W , M_Z ,
 - Missing components
 - origin of symmetry breaking (Higgs Mechanism)
- The Hunt for the Higgs Boson
 - Limits from LEP2 and future accelerators
- Other investigations
 - supersymmetry, extra dimensions

The Next Linear Collider

- Acceleration of electrons in a circular accelerator is plagued by Nature's resistance to acceleration
 - Synchrotron radiation
 - $\Delta E = 4\pi/3 (e^2\beta^3\gamma^4 / R)$ per turn (recall $\gamma = E/m$, so $\Delta E \sim E^4/m^4$)
 - eg. LEP2 $\Delta E = 4 \text{ GeV}$ Power $\sim 20 \text{ MW}$
- For this reason, at very high energy it is preferable to accelerate electrons in a linear accelerator, rather than a circular accelerator

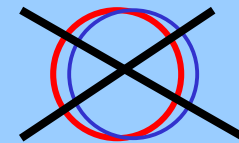
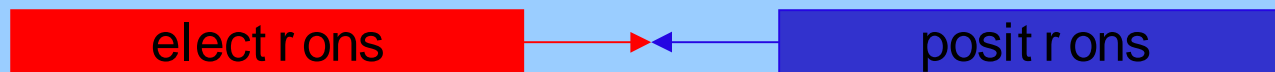

Linear Colliders

- Synchrotron radiation
 - $\Delta E \sim (E^4 / m^4 R)$
- Therefore
 - Cost (circular) $\sim a R + b \Delta E \sim a R + b (E^4 / m^4 R)$
 - Optimization $R \sim E^2 \Rightarrow \text{Cost} \sim c E^2$
 - Cost (linear) $\sim a' L$, where $L \sim E$

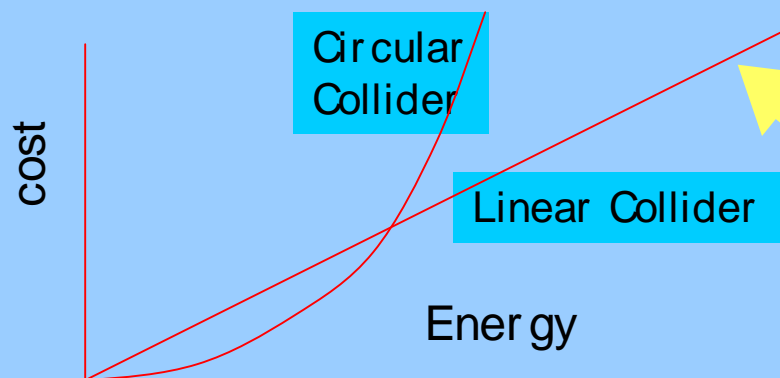

- At high energy, linear collider is more cost effective

The Linear Collider

- A plan for a high-energy, high-luminosity, electron-positron collider (international project)
 - $E_{cm} = 500 - 1000 \text{ GeV}$
 - Length $\sim 25 \text{ km}$ $\sim 15 \text{ miles}$
- Physics Motivation for the NLC
 - Elucidate Electroweak Interaction
 - particular symmetry breaking
 - This includes
 - Higgs bosons
 - supersymmetric particles
 - extra dimensions
- Construction could begin around 2005-6 and operation around 2011-12

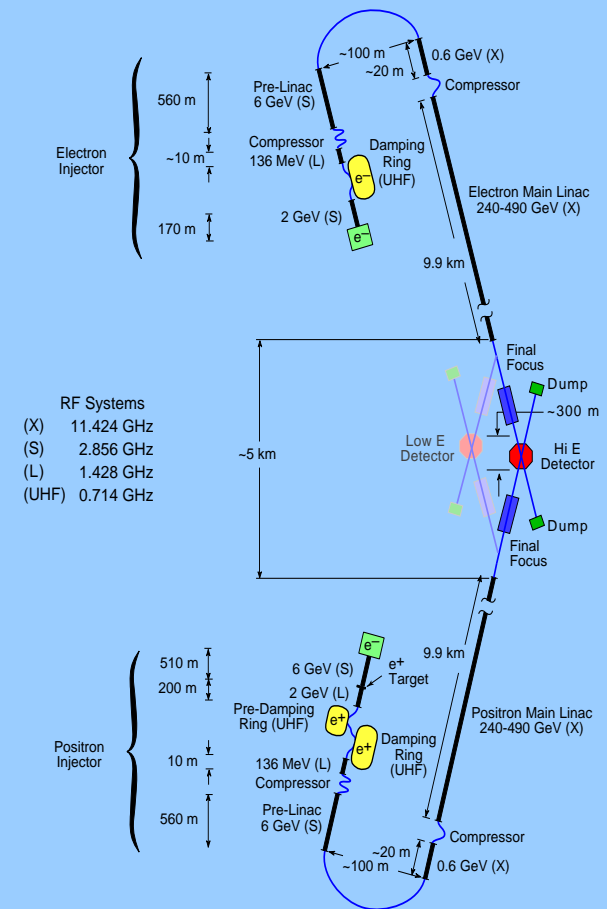

not to scale

The First Linear Collider

- This concept was demonstrated at SLAC in a linear collider prototype operating at ~ 91 GeV (the SLC)
 - Oregon collaborated
- SLC was built in the 80's within the existing SLAC linear accelerator
- Operated 1989-98
 - precision Z^0 measurements
 - established LC concepts

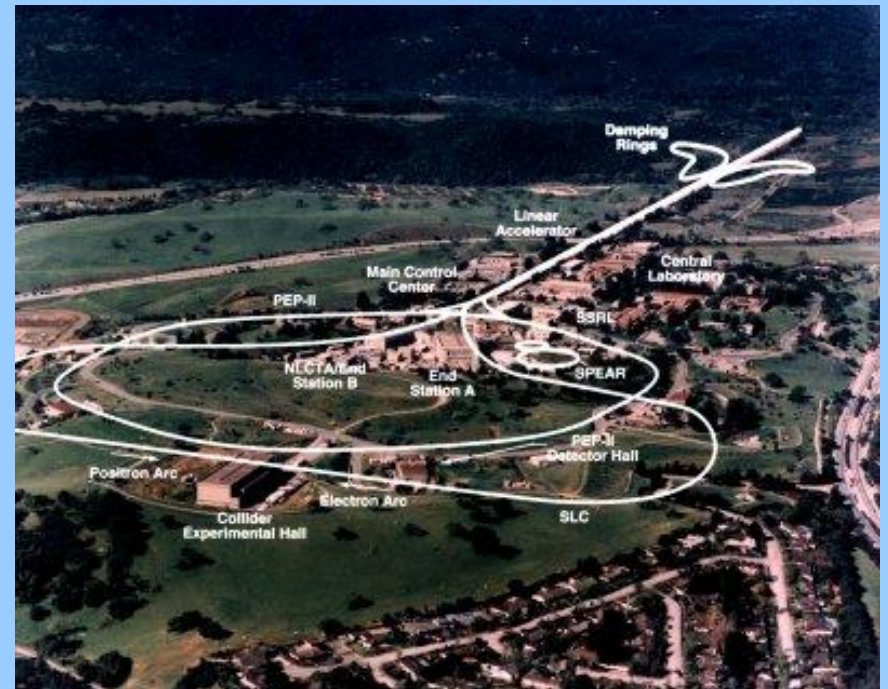



The Next Linear Collider



- DOE/ NSF High Energy Physics Advisory Panel
 - Subpanel on Long Range Planning for U.S. High Energy Physics
 - A year long study was concluded early this year with the release of the report of recommendations
 - A high-energy, high-luminosity electron-positron linear collider should be the highest priority of the US HEP community, preferably one sited in the US

The “next” Linear Collider

The next Linear Collider proposals include plans to deliver **a few hundred fb⁻¹** of integrated lum. per year

		 TESLA	 JLC-C	 NLC/ JLC-X *
		(DESY-Germany)	(Japan)	(SLAC/KEK-Japan)
$\mathcal{L}_{\text{design}}$	(10 ³⁴)	3.4 → 5.8	0.43	2.2 → 3.4
E_{CM}	(GeV)	500 → 800	500	500 → 1000
Eff. Gradient	(MV/ m)	23.4 → 35	34	70
RF freq.	(GHz)	1.3	5.7	11.4
Δt_{bunch}	(ns)	337 → 176	2.8	1.4
# bunch/ train		2820 → 4886	72	190
Beamstrahlung	(%)	3.2 → 4.4		4.6 → 8.8

There will only be one in the world, but the technology choice remains to be made

* US and Japanese X-band R&D cooperation, but machine parameters may differ

NLC Engineering



- Power per beam
 - 6.6 MW cw (250 GW during pulse train of 266 nsec)
(500,000 GW within a bunch of the train)

- Beam size at interaction
 - 245 nanometers x 3 nanometers

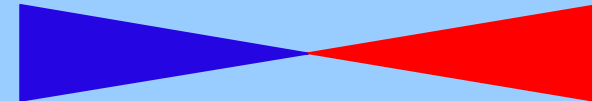

Stabilize

- Beam flux at interaction
 - 10^{12} MW/cm² cw (3×10^{13} GW/cm² during pulse train)
- Current density
 - 6.8×10^{12} A/m² (1.4×10^{15} A/m² within a bunch)
- Induced magnetic field (beam-beam)
 - $\gg 10$ Tesla **beam-beam induced bremsstrahlung - “beamstrahlung”**

The “next” Linear Collider

Standard Package:

$e^+ e^-$ Collisions

Initially at 500 GeV

Electron Polarization $\geq 80\%$

Options:

Energy upgrades to $\sim 1.0 - 1.5$ TeV

Positron Polarization ($\sim 40 - 60\%$?)

$\gamma\gamma$ Collisions

$e^- e^-$ and $e^- \gamma$ Collisions

Giga-Z (precision measurements)

Special Advantages of Experiments at the Linear Collider

Elementary interactions at known E_{cm}^*
eg. $e^+e^- \rightarrow ZH$

Democratic Cross sections
eg. $\sigma(e^+e^- \rightarrow ZH) \sim 1/2 \sigma(e^+e^- \rightarrow d\bar{d})$

Inclusive Trigger
total cross-section

Highly Polarized Electron Beam
 $\sim 80\%$

Exquisite vertex detection
eg. $R_{\text{beampipe}} \sim 1 \text{ cm}$ and $\sigma_{\text{hit}} \sim 3 \mu\text{m}$

Calorimetry with Jet Energy Flow
 $\sigma_E/E \sim 30\text{-}40\%/\sqrt{E}$

* beamstrahlung must be dealt with, but it's manageable

Linear Collider Detectors

The Linear Collider provides very special experimental conditions (eg. superb vertexing and jet calorimetry)

CCD Vertex Detectors

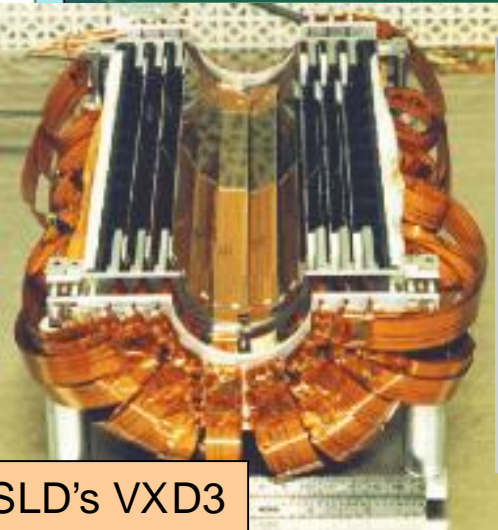
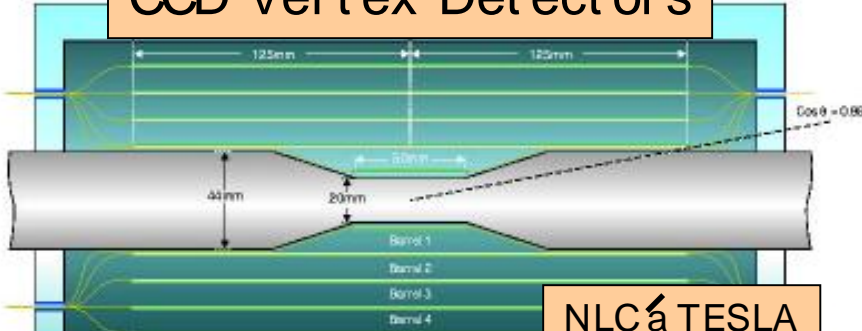

SLD's VXD3

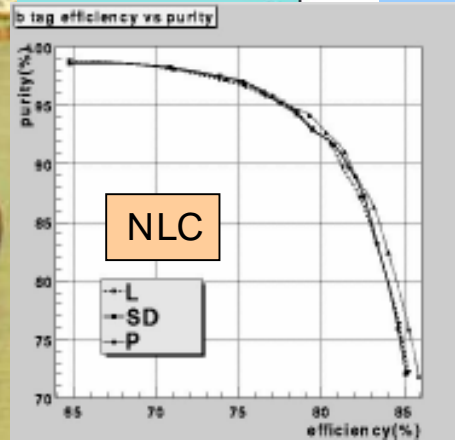

NLC

Silicon/ Tungsten Calorimetry

SLD Lum (1990)
Aleph Lum (1993)
Opal Lum (1993)

Snowmass - 96 Proceedings
NLC Detector - fine gran. Si/W

Now TESLA & NLD
have proposed Si/W
as central elements in
jet flow measurement

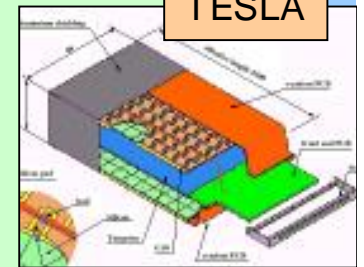

TESLA

Electroweak Symmetry Breaking

- A primary goal of the Next Linear Collider is to elucidate the origin of Electroweak Symmetry Breaking
 - The weak nuclear force and the electromagnetic force have been unified into a single description $SU(2) \times U(1)_Y$
 - Why is this symmetry hidden?
 - The answer to this appears to promise deep understanding of fundamental physics
 - the origin of mass
 - supersymmetry and possibly the origin of dark matter
 - additional unification (strong force, gravity) and possibly hidden space-time dimensions

Electromagnetism and Radioactivity

- Maxwell unified Electricity and Magnetism with his famous equations (1873)
- Matter spontaneously emits penetrating radiation
 - Becquerel uranium emissions in 1896
 - The Curies find radium emissions by 1898

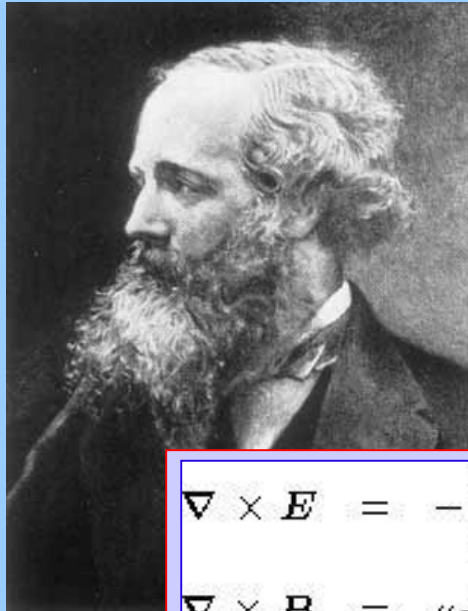

$$\begin{aligned}\nabla \times \mathbf{E} &= -\frac{\partial \mathbf{B}}{\partial t} \\ \nabla \times \mathbf{B} &= \mu_0 \mathbf{J} + \frac{1}{c^2} \frac{\partial \mathbf{E}}{\partial t} \\ \nabla \cdot \mathbf{E} &= \rho / \epsilon_0 \\ \nabla \cdot \mathbf{B} &= 0\end{aligned}$$

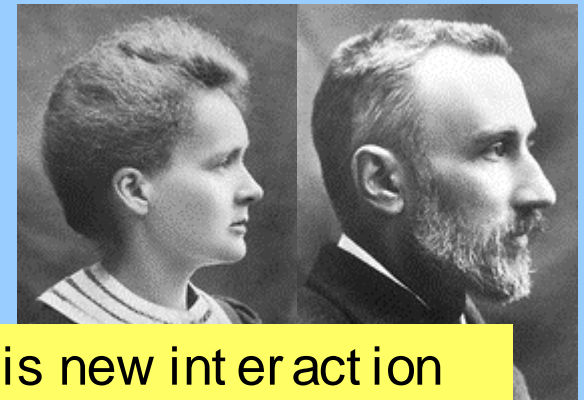
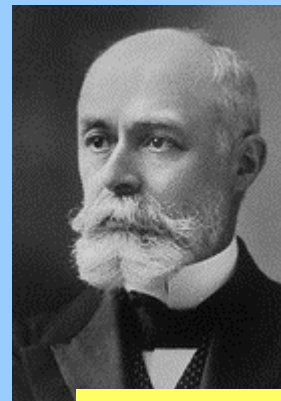
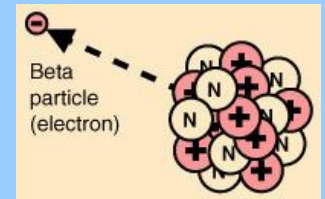

Could this new interaction (the weak force) be related to E&M?

Advancing understanding of Beta Decay

- Pauli realizes there must be a neutral invisible particle accompanying the beta particle:

– the neutrino

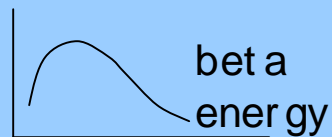

- Fermi develops a theory of beta decay (1934)

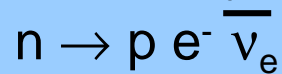

- 1956 - Neutrino discovered by Reines and Cowan - Savannah River Reactor, SC

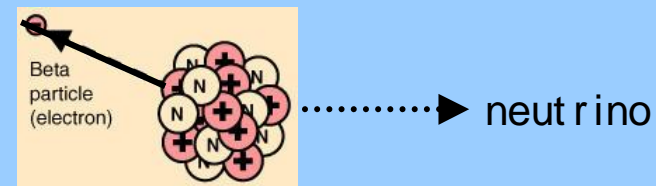

State of EM and Weak Theory in 1960

Weak Interaction Theory

- Fermi's 1934 point like, four-fermion interaction theory

$$M = G J_{\text{baryon}}^{\text{weak}} J_{\text{lepton}}^{\text{weak}} = G (\bar{\psi}_p O \psi_n) (\bar{\psi}_e O \psi_\nu)$$

V-A



$$W = \frac{2\pi}{\hbar} G^2 |M|^2 \frac{dN}{dE_0}$$

- Theory fails at higher energy, since rate increases with energy, and therefore will violate the “unitarity limit”
 - Speculation on heavy mediating bosons but no theoretical guidance on what to expect

Status of EM and Weak Theory in 1960

Quantum Electrodynamics (QED)

- Dirac introduced theory of electron - 1926
- Through the pioneering theoretical work of Feynman, Schwinger, Tomonga, and others, a theory of electrons and photons was worked out with precise predictive power
- example: magnetic dipole of the electron
[$(g-2)/2$] $\mu = g (e\hbar/2mc) S$

- current values of electron $(g-2)/2$

theory: $0.5 (\alpha/\pi) - 0.32848 (\alpha/\pi)^2 + 1.19 (\alpha/\pi)^3 + \dots$

$$= (115965230 \pm 10) \times 10^{-11}$$

experiment = $(115965218.7 \pm 0.4) \times 10^{-11}$



The New Symmetry Emerges

VOLUME 19, NUMBER 21

PHYSICAL REVIEW LETTERS

20 NOVEMBER 1967

A MODEL OF LEPTONS*

Steven Weinberg†

Leptons interact only with photons, and with the intermediate bosons that presumably mediate weak interactions. What could be more natural than to unite¹ these spin-one bosons into a multiplet of gauge fields? Standing in the way of this synthesis are the obvious differences in the masses of the photon and intermediate meson, and in their couplings. We might hope to understand these differences

slightly larger than that (0.23%) obtained from dominance model of Ref. 2. This seems to be in the other case of the ratio $\Gamma(\eta \rightarrow \pi^+\pi^-\gamma)/\Gamma(\eta \rightarrow \pi^+\pi^-\gamma)$ calculated in Refs. 12 and 14. Brown and P. Singer, Phys. Rev. Lett. 19, 100 (1967).

MS*

Physics Department,
Cambridge, Massachusetts
02139

a right-handed singlet

$$R = [\frac{1}{2}(1-\gamma_5)]e.$$



Enter Electroweak Unification

- Weinberg realized that the vector field responsible for the EM force
 - (the photon)
- and the vector fields responsible for the Weak force
 - (yet undiscovered W^+ and W^-)
- could be unified if another vector field, mediated by a heavy neutral boson (Z), were to exist
- This same notion occurred to Salam



$$L = g\mathbf{J}_\mu \cdot \mathbf{W}_\mu + g' J_\mu^Y B_\mu$$

$$W_\mu^{(3)} = \frac{gZ_\mu + g'A_\mu}{\sqrt{g^2 + g'^2}} \quad B_\mu = \frac{-g'Z_\mu + gA_\mu}{\sqrt{g^2 + g'^2}} \rightarrow e J_\mu^{(em)} A_\mu$$

$$\tan \theta_W = g'/g$$

$$\sin^2 \theta_W = g'^2 / (g'^2 + g^2)$$

$$e = g \sin \theta_W = g' \cos \theta_W$$

Electroweak Unification

- There remained a phenomenological problem:
 - where were the effects of the Z^0
- These do not appear so clearly in Nature
 - they are small effects in the atomic electron energy level
- One has to look for them in high energy experiments

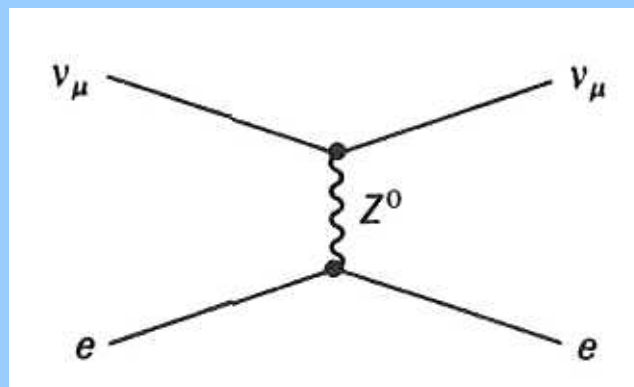

Neutral Currents Discovered!

- 1973 - giant bubble chamber Gargamelle at CERN
 - 12 cubic meters of heavy liquid

- Muon neutrino beam
- Electron recoil
- Nothing else
- Neutral Current Discovered

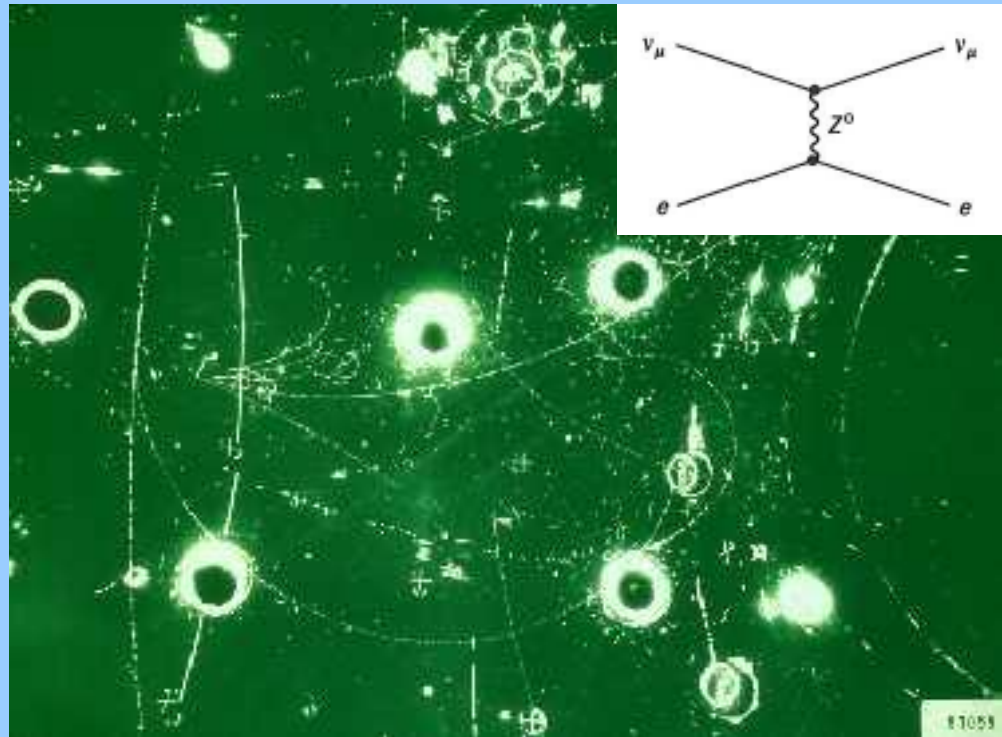

that is, the effect of the Z^0

Confirmation of Neutral Currents

- Weinberg-Salam Model predicts there should be some parity violation in polarized electron scattering
 - The dominant exchange is the photon (L/R symmetric)
 - A small addition of the weak neutral current exchange leads to an expected asymmetry of $\sim 10^{-4}$ between the scattering of left and right-handed electrons

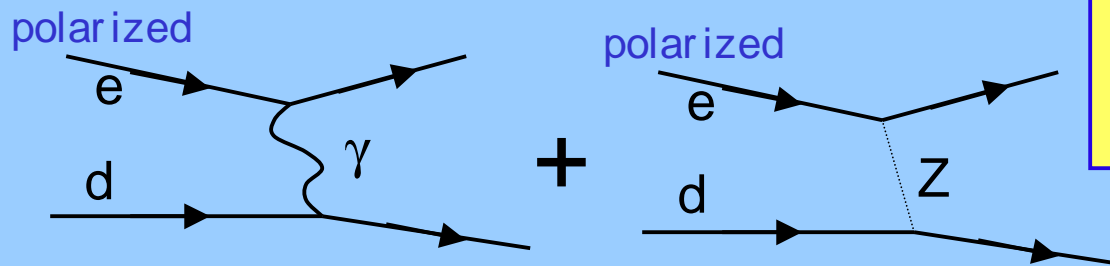

Z exchange violates parity

$$g_R \neq g_L$$

An asymmetry of 10^{-4}

- This was observed by Prescott et al. at SLAC in 1978, confirming the theory, and providing the first accurate measurement of the weak mixing angle

$$\sin^2\theta_W = 0.22 \pm 0.02$$



The W and Z Masses

- Knowing $\sin^2\theta_W$ allows one to predict the W and Z boson masses in the Weinberg-Salam Model

$$M_{W^\pm} = \left(\frac{e^2 \sqrt{2}}{8G \sin^2 \theta_W} \right)^{1/2} = \frac{37.4}{\sin \theta_W} \text{ GeV} \sim 80 \text{ GeV}/c^2$$

$$M_{Z^0} = \frac{M_{W^\pm}}{\cos \theta_W} = \frac{75}{\sin 2\theta_W} \text{ GeV} \sim 90 \text{ GeV}/c^2$$

Discovery of the W and Z

- Motivated by these predictions, experiments at CERN were mounted to find the W and Z

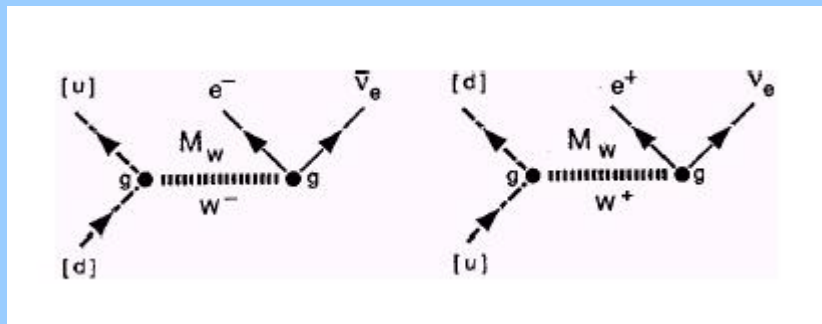

β^- decay

β^+ decay

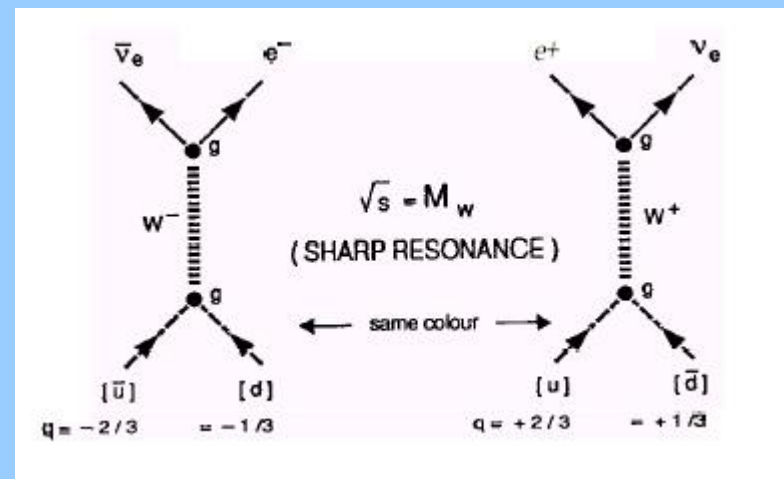

q anti- q annihilation to W^\pm

Discovery of the W and Z

- 1981 - antiprotons were stored in the CERN SPS ring and brought into collision with protons



Discovery of the W and Z

- 1981 UA1

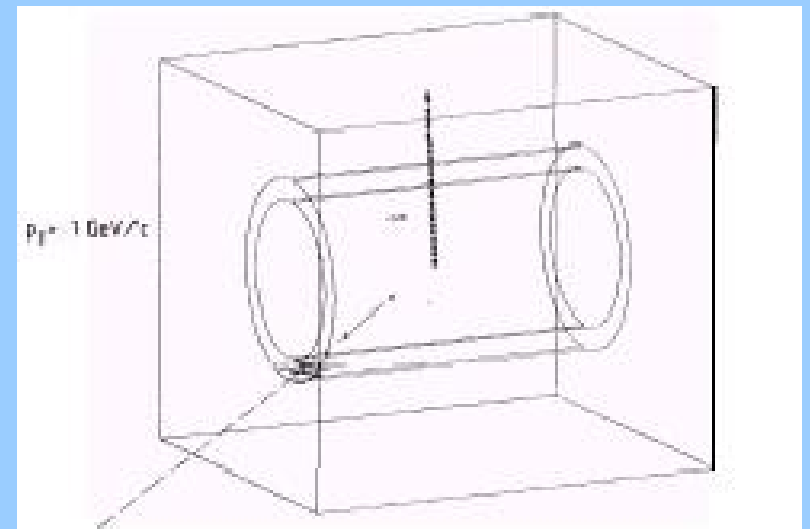
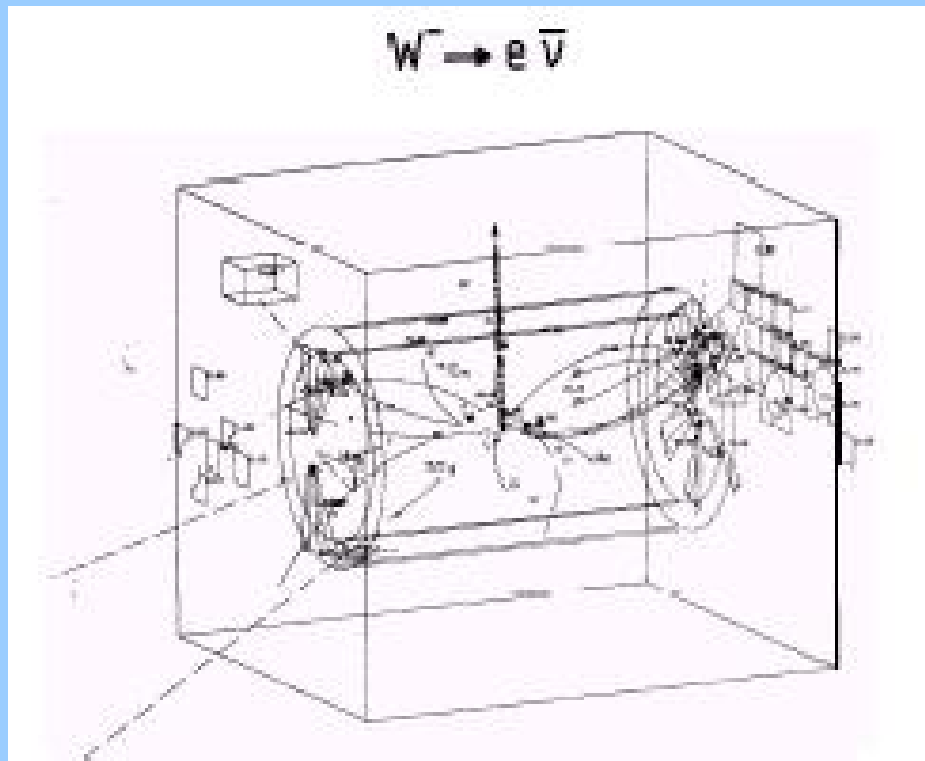

Discovery of the W and Z

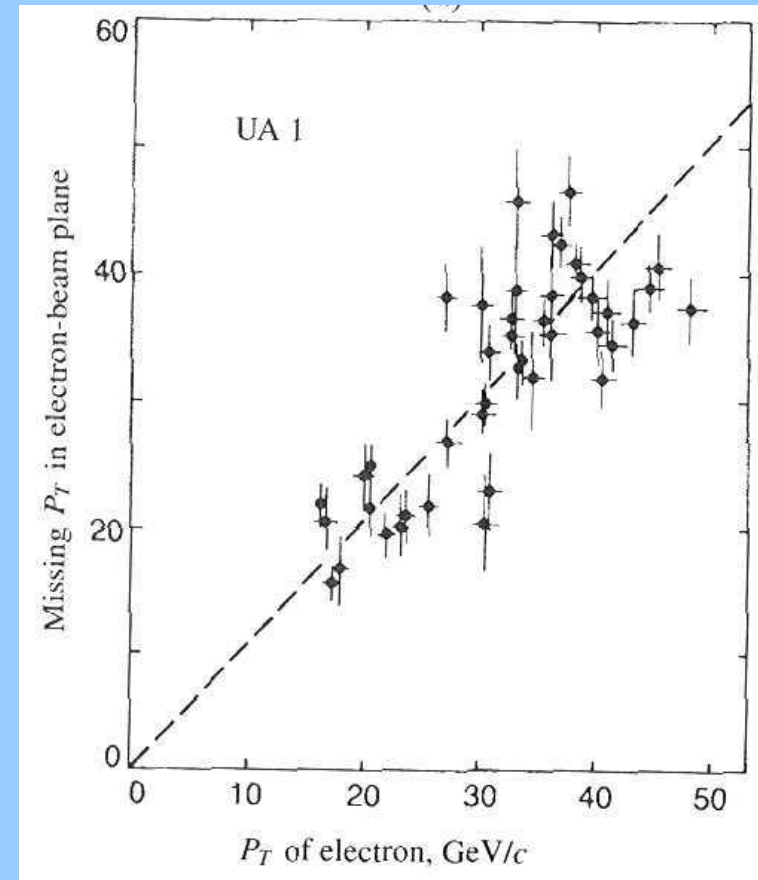
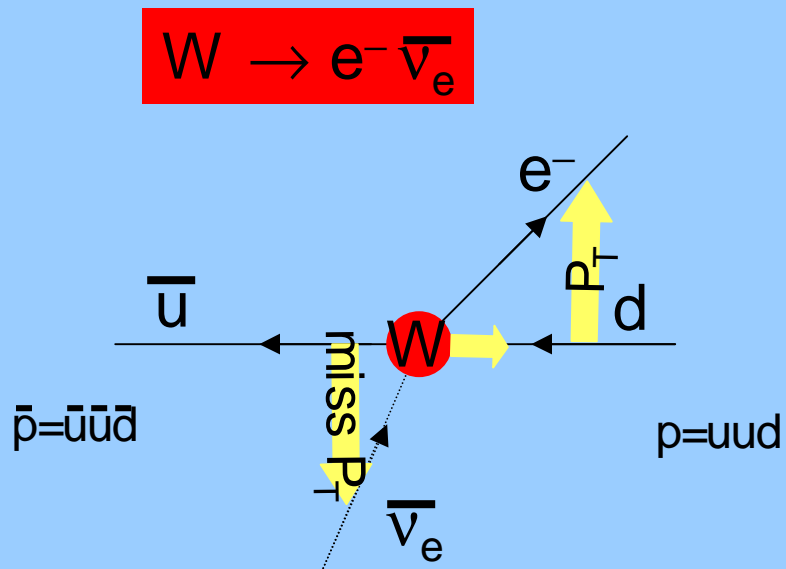

Discovery of the W and Z

- That was 20 years ago
- Since then:
 - precision studies at Z^0 Factories
 - LEP and SLC
 - precision W measurements at colliders
 - LEP2 and Tevatron

$$M_Z = 91187.5 \pm 2.1 \text{ MeV}$$

$$M_W = 80451 \pm 33 \text{ MeV}/c^2$$

- These precise measurements (along with other precision measurements) test the Standard Model with keen sensitivity
 - eg. are all observables consistent with the same value of $\sin^2\theta_W$

Electroweak Symmetry Breaking

- Confirmation of the completeness of the Standard Model (LEP2)

$$e^+e^- \rightarrow W^+W^-$$

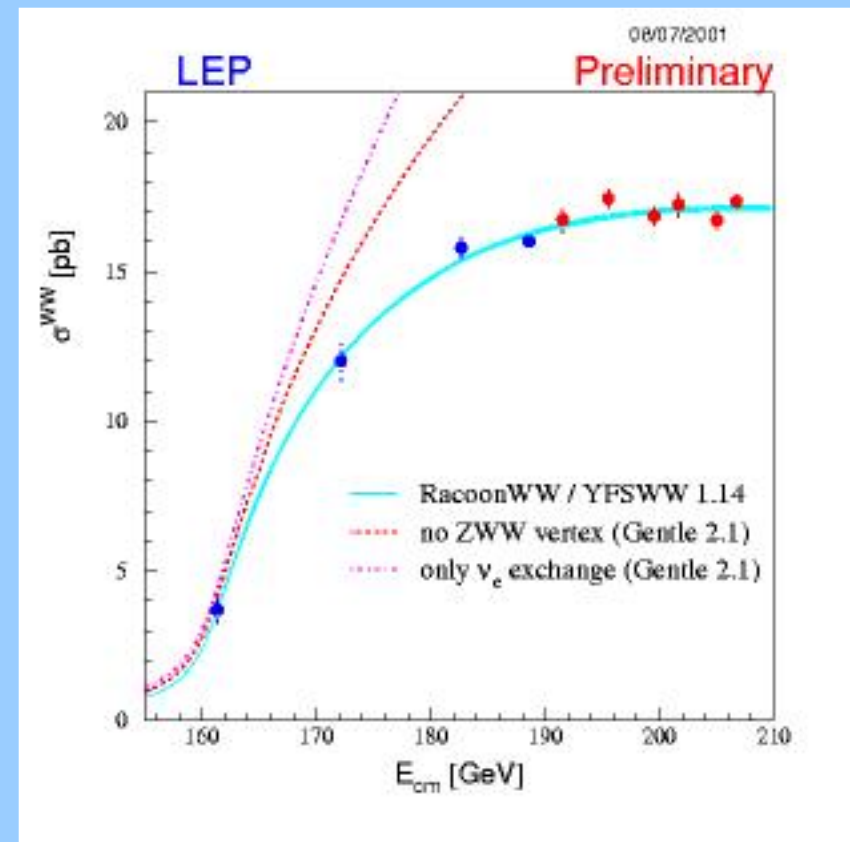
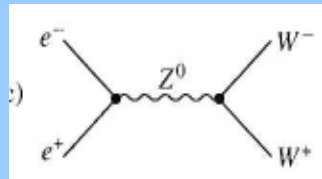
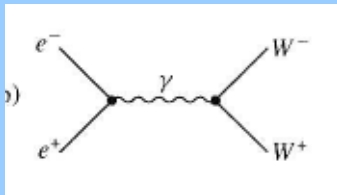
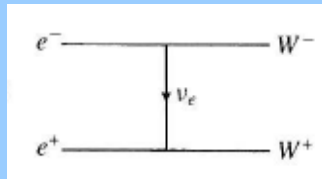

The Higgs Boson

- Why is the underlying SU(2)xU(1) symmetry

$$L = g\mathbf{J}_\mu \cdot \mathbf{W}_\mu + g' J_\mu^Y B_\mu$$

broken

$$\begin{aligned} & -\frac{g}{2\sqrt{2}} \sum_i \bar{\psi}_i \gamma^\mu (1 - \gamma^5)(T^+ W_\mu^+ + T^- W_\mu^-) \psi_i \\ & - e \sum_i q_i \bar{\psi}_i \gamma^\mu \psi_i A_\mu \\ & - \frac{g}{2 \cos \theta_W} \sum_i \bar{\psi}_i \gamma^\mu (g_V^i - g_A^i \gamma^5) \psi_i Z_\mu . \end{aligned}$$

- Theoretical conjecture is the Higgs Mechanism:
a non-zero vacuum expectation value of a scalar field,
gives mass to W and Z and leaves photon massless

Standard Model Fit

- $M_H = 88^{+53}_{-35} \text{ GeV}/c^2$

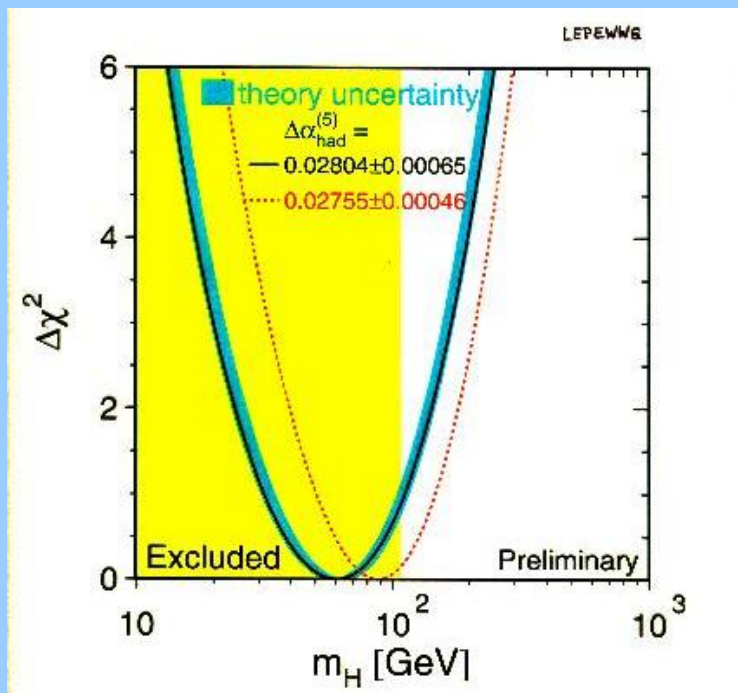

Summer 2001

	Measurement	Pull	$(O^{\text{meas}} - O^{\text{fit}}) / \sigma^{\text{meas}}$
$\Delta\alpha_{\text{had}}^{(5)}(m_Z)$	0.02761 ± 0.00036	-0.35	
m_Z [GeV]	91.1875 ± 0.0021	.03	
Γ_Z [GeV]	2.4952 ± 0.0023	-0.48	
σ_{had}^0 [nb]	41.540 ± 0.037	1.60	
R_l	20.767 ± 0.025	1.11	
$A_{\text{fb}}^{0,l}$	0.01714 ± 0.00095	.69	
$A_l(P_e)$	0.1465 ± 0.0033	-0.54	
R_b	0.21646 ± 0.00065	1.12	
R_c	0.1719 ± 0.0031	-0.12	
$A_{\text{fb}}^{0,b}$	0.0990 ± 0.0017	-2.90	
$A_{\text{fb}}^{0,c}$	0.0685 ± 0.0034	-1.71	
A_b	0.922 ± 0.020	-0.64	
A_c	0.670 ± 0.026	.06	
$A_l(\text{SLD})$	0.1513 ± 0.0021	1.47	
$\sin^2\theta_{\text{eff}}^{\text{lept}}(Q_{\text{fb}})$	0.2324 ± 0.0012	.86	
$m_W^{(\text{LEP})}$ [GeV]	80.450 ± 0.039	1.32	
m_t [GeV]	174.3 ± 5.1	-0.30	
$m_W^{(\text{TEV})}$ [GeV]	80.454 ± 0.060	.93	
$\sin^2\theta_W(\nu N)$	0.2255 ± 0.0021	1.22	
$Q_W(\text{Cs})$	-72.50 ± 0.70	.56	

The Higgs Boson

- This field, like any field, has quanta, the Higgs Boson or Bosons
 - Minimal model - one complex doublet \Rightarrow 4 fields
 - 3 “eaten” by W^+ , W^- , Z to give mass
 - 1 left as physical Higgs
- This spontaneously broken local gauge theory is renormalizable - t’Hooft (1971)
- The Higgs boson properties
 - Mass $< \sim 800 \text{ GeV}/c^2$ (unitarity arguments)
 - Strength of Higgs coupling increases with mass
 - fermions: $g_{ffh} = m_f / v$ $v = 246 \text{ GeV}$
 - gauge boson: $g_{wwh} = 2 m_Z^2 / v$



Particle Physics History of Anticipated Particles

Positron	Dirac theory of the electron
Neutrino	missing energy in beta decay
Pion meson	Yukawa's theory of strong interaction
Charmed quark	absence of flavor changing neutral currents
Bottom quark	Kobayashi-Maskawa theory of CP violation
W boson	Weinberg-Salam electroweak theory
Z boson	“ “
Top quark	Mass predicted by precision Z^0 measurements
Higgs boson	Electroweak theory and experiments

The Search for the Higgs Boson

- LEP II (1996-2000)
 - $M_H > 114 \text{ GeV}/c^2$ (95% conf.)

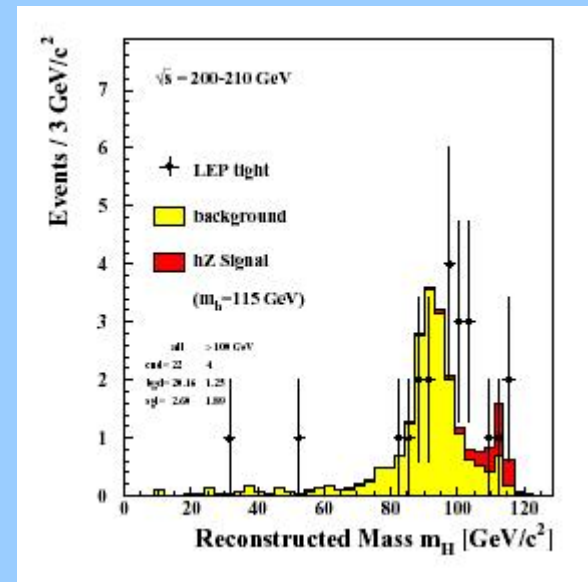
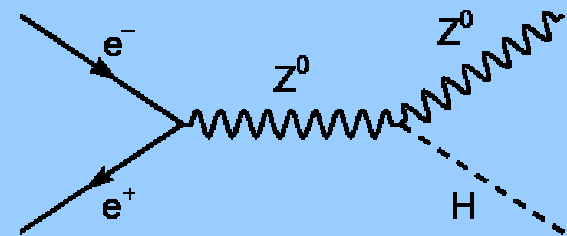

The Search for the Higgs Boson

- Tevatron at Fermilab
 - Proton/anti-proton collisions at $E_{\text{cm}}=2000$ GeV
 - Now
- LHC at CERN
 - Proton/proton collisions at $E_{\text{cm}}=14,000$ GeV
 - Begins operation ~2007



Indications for a Light Standard Model-like Higgs

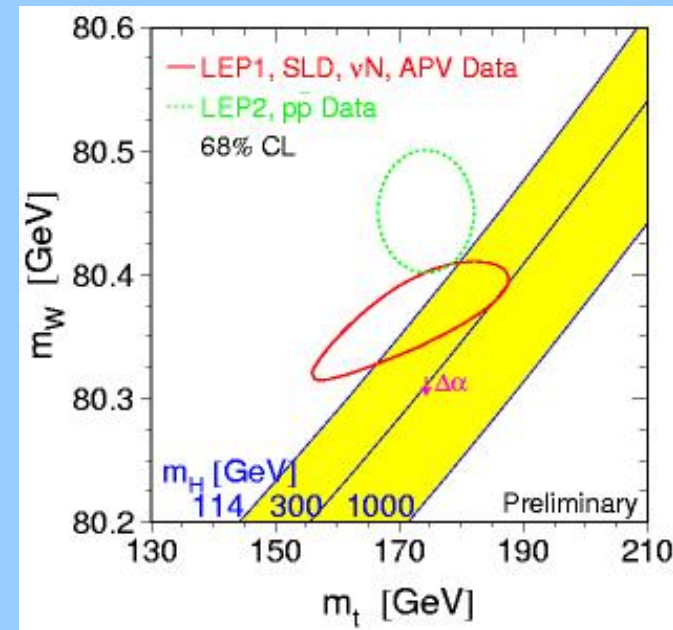
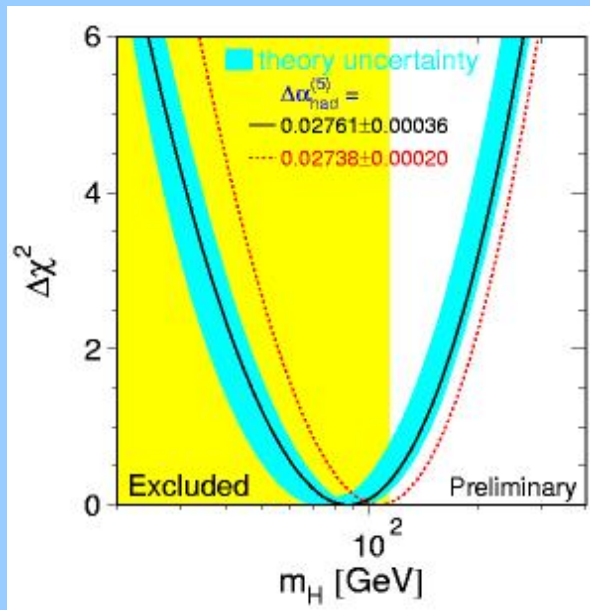

(SM) $M_{\text{higgs}} < 195 \text{ GeV}$ at 95% CL.
LEP2 limit $M_{\text{higgs}} > 114.1 \text{ GeV}$.
Tevatron can discover up to 180 GeV

**W mass ($\pm 33 \text{ MeV}$)
 and top mass ($\pm 5 \text{ GeV}$)
 agree with precision measures
 and indicate low SM Higgs mass**

**LEP Higgs search – Maximum Likelihood for Higgs signal at
 $m_H = 115.6 \text{ GeV}$ with overall significance (4 experiments) $\sim 2\sigma$**

Establishing Standard Model Higgs

precision studies of the Higgs boson will be required to understand Electroweak Symmetry Breaking; just finding the Higgs is of limited value

We expect the Higgs to be discovered at LHC (or Tevatron) and the measurement of its properties will begin at the LHC

We need to measure the full nature of the Higgs to understand EWSB

The 500 GeV (and beyond) Linear Collider is the tool needed to complete these *precision* studies

References:

TESLA Technical Design Report
Linear Collider Physics Resource Book for Snowmass 2001
(contain references to many studies)

Colloquium, Corvallis, OR,
J. Brau, May 6, 2002

Candidate Models for Electroweak Symmetry Breaking

Standard Model Higgs

excellent agreement with EW precision measurements
implies $M_H < 200$ GeV (but theoretically ugly - h'archy prob.)

MSSM Higgs

expect $M_h < \sim 135$ GeV
light Higgs boson (h) may be very "SM Higgs-like"
(de-coupling limit)

Non-exotic extended Higgs sector
eg. 2HDM

Strong Coupling Models

New strong interaction

The NLC will provide critical data for all of these possibilities

The Higgs Physics Program of the Next Linear Collider

Electroweak precision measurements suggest there should be a relatively light Higgs boson:

When we find it, we will want to study its nature.
The LC is capable of contributing significantly to this study.

Mass Measurement
Total width
Particle couplings
 vector bosons
 fermions (including top)
Spin-parity-charge conjugation
Self-coupling

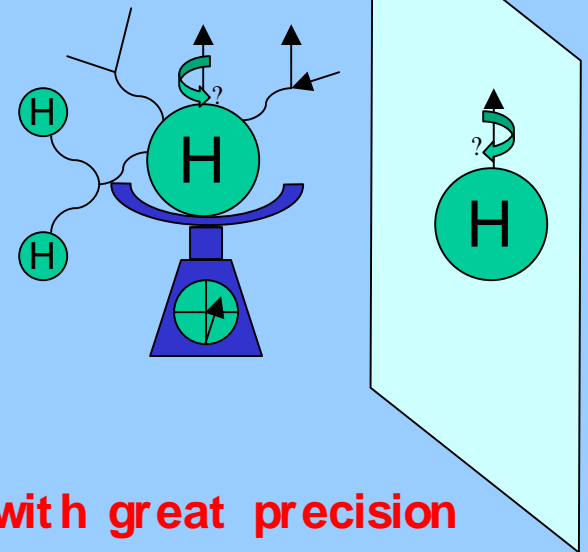

The Linear Collider could measure all this with great precision

Example of Precision of Higgs Measurements at the Next Linear Collider

For $M_H = 140 \text{ GeV}$, 500 fb^{-1} @ 500 GeV

Mass Measurement

$$\delta M_H \approx 60 \text{ MeV} \approx 5 \times 10^{-4} M_H$$

Total width

$$\delta \Gamma_H / \Gamma_H \approx 3 \%$$

Particle couplings

$t\bar{t}$

(needs higher \sqrt{s} for 140 GeV ,
except through $H \rightarrow g\bar{g}$)

$b\bar{b}$

$$\delta g_{Hb\bar{b}} / g_{Hb\bar{b}} \approx 2 \%$$

$c\bar{c}$

$$\delta g_{Hc\bar{c}} / g_{Hc\bar{c}} \approx 22.5 \%$$

$\tau^+\tau^-$

$$\delta g_{H\tau\tau} / g_{H\tau\tau} \approx 5 \%$$

WW^*

$$\delta g_{HWW} / g_{HWW} \approx 2 \%$$

ZZ

$$\delta g_{HZZ} / g_{HZZ} \approx 6 \%$$

$g\bar{g}$

$$\delta g_{Hgg} / g_{Hgg} \approx 12.5 \%$$

$\gamma\gamma$

$$\delta g_{H\gamma\gamma} / g_{H\gamma\gamma} \approx 10 \%$$

Spin-parity-charge conjugation

establish $J^{PC} = 0^{++}$

Self-coupling

$$\delta \lambda_{HHH} / \lambda_{HHH} \approx 32 \%$$

(statistics limited)

If Higgs is lighter, precision is often better

Colloquium, Corvallis, OR,

J. Brau, May 6, 2002

Higgs Production Cross-section at the Next Linear Collider

NLC ~ 500 event s / fb

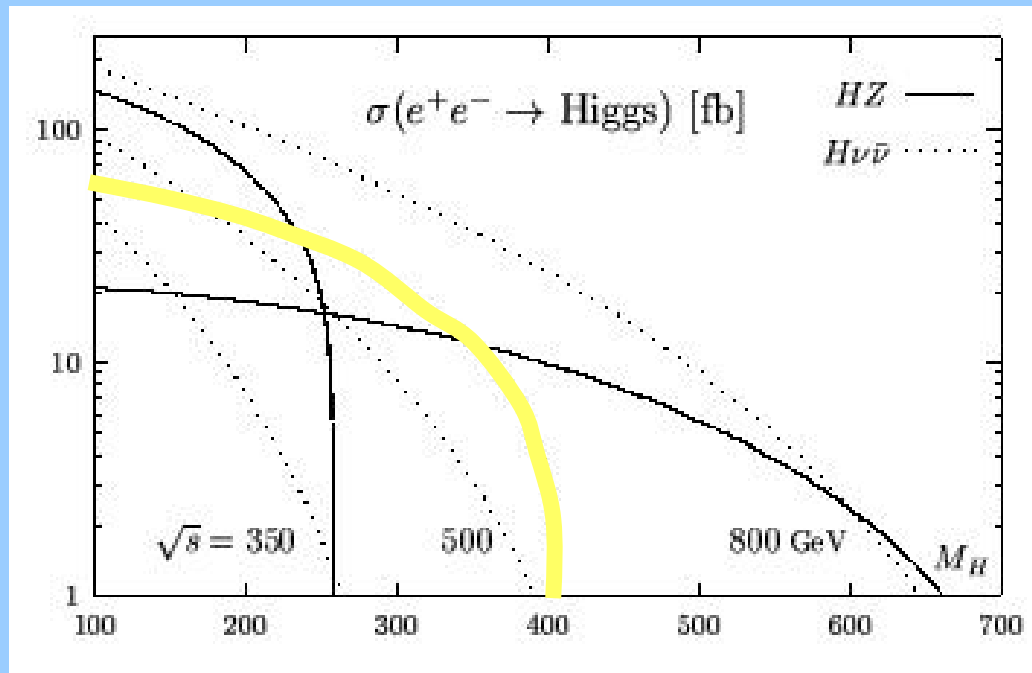

Higgs-strahlung

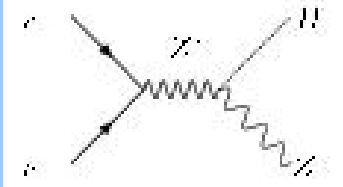

WW fusion

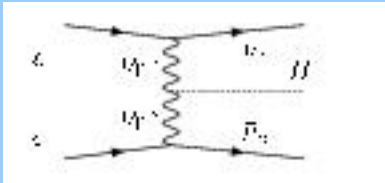

Recall, $\sigma_{\text{pt}} = 87 \text{ nb} / (E_{\text{cm}})^2 \sim 350 \text{ fb} @ 500 \text{ GeV}$

Higgs Studies

- the Power of Simple Reactions

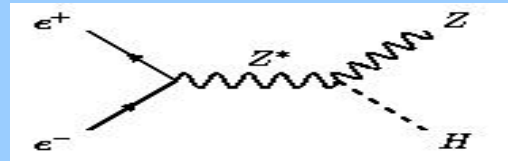

The LC can produce the Higgs recoiling from a Z, with known CM energy[↓], which provides a powerful channel for unbiased tagging of Higgs events, allowing measurement of even invisible decays (↓ - some beamstrahlung)

- Tag $Z \rightarrow l^+ l^-$
- Select $M_{\text{recoil}} = M_{\text{Higgs}}$

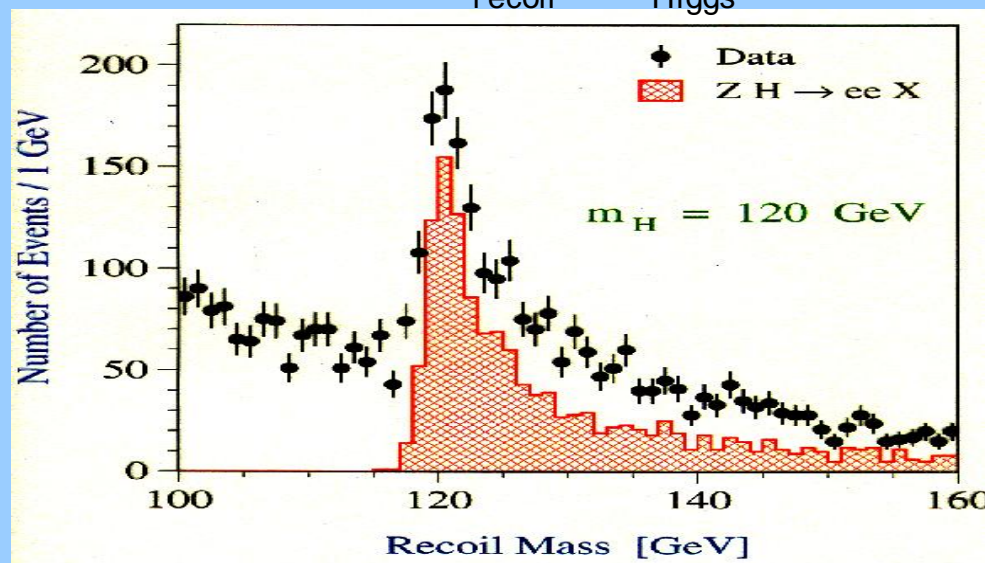

Invisible decays are included

Higgs Couplings - the Branching Ratios

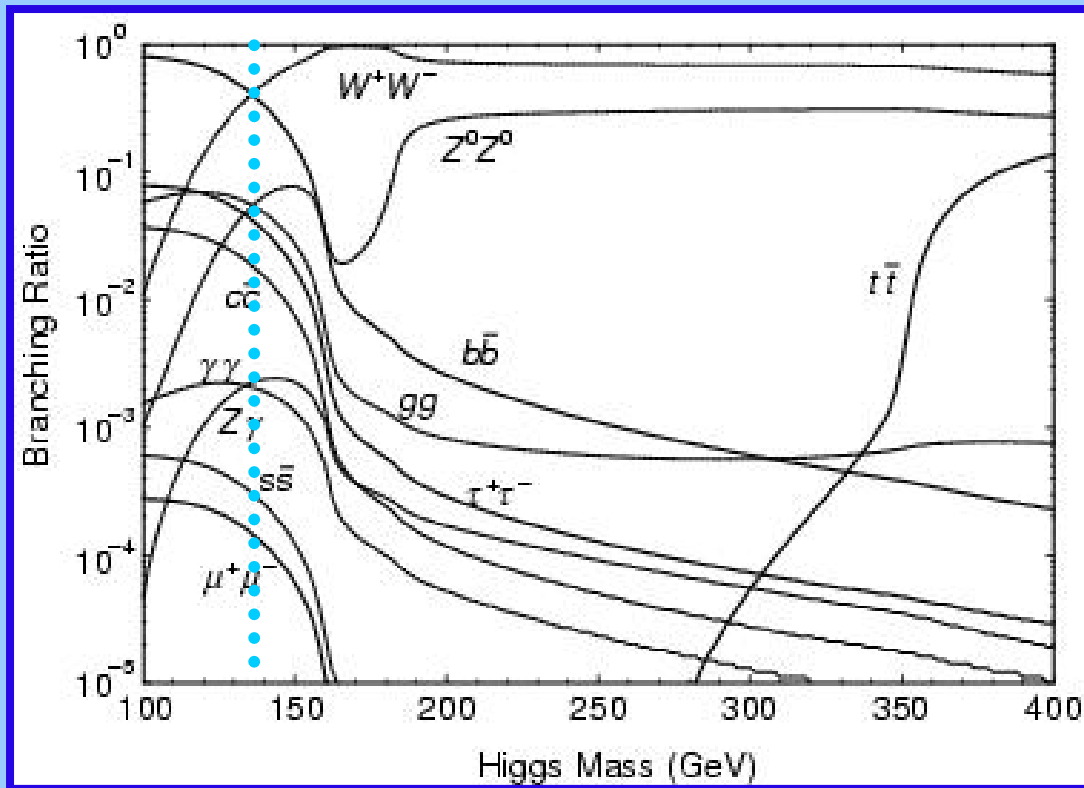

bb	$\delta g_{Hbb} / g_{Hbb} \approx 2 \%$
cc	$\delta g_{Hcc} / g_{Hcc} \approx 22.5 \%$
$\tau^+\tau^-$	$\delta g_{H\tau\tau} / g_{H\tau\tau} \approx 5 \%$
WW^*	$\delta g_{Hww} / g_{Hww} \approx 2 \%$
ZZ	$\delta g_{HZZ} / g_{HZZ} \approx 6 \%$
gg	$\delta g_{Hgg} / g_{Hgg} \approx 12.5 \%$
$\gamma\gamma$	$\delta g_{H\gamma\gamma} / g_{H\gamma\gamma} \approx 10 \%$

Measurement of BR's is powerful indicator of new physics

e.g. in MSSM, these differ from the SM in a characteristic way.

Higgs BR must agree with MSSM parameters from many other measurements.

Higgs Spin Parity and Charge Conjugation (J^{PC})

$H \rightarrow \gamma\gamma$ or $\gamma\gamma \rightarrow H$ rules out $J=1$ and indicates $C=+1$

Threshold cross section ($e^+e^- \rightarrow ZH$) for $J=0$
 $\sigma \sim \beta$, while for $J > 0$, generally higher power of β (assuming $n = (-1)^J P$)

Production angle (θ) and Z decay angle in Higgs-strahlung reveals $J^P(e^+e^- \rightarrow ZH \rightarrow ffH)$

	$J^P = 0^+$	$J^P = 0^-$	
$d\sigma/d\cos\theta$	$\sin^2\theta$	$(1 - \sin^2\theta)$	
$d\sigma/d\cos\phi$	$\sin^2\phi$	$(1 \pm \cos\phi)^2$	

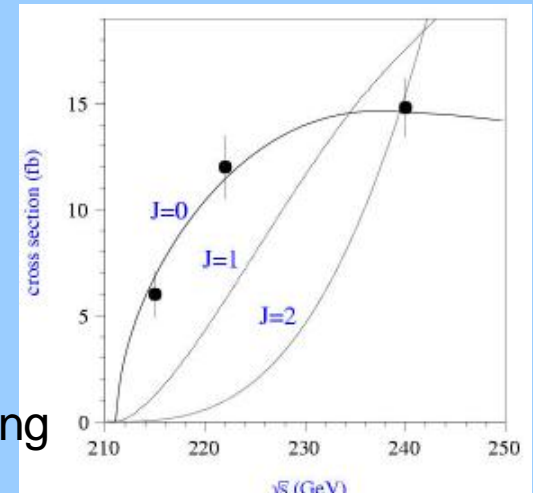

LC Physics Resource Book, Fig 3.23(a)

ϕ is angle of the fermion, relative to the Z direction of flight, in Z rest frame

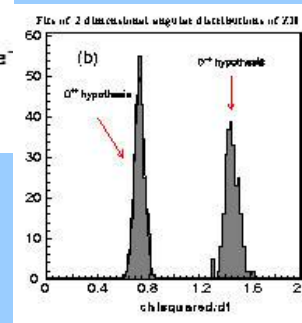
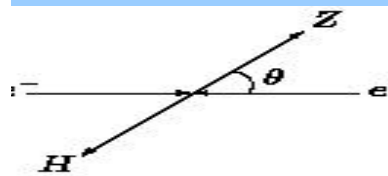
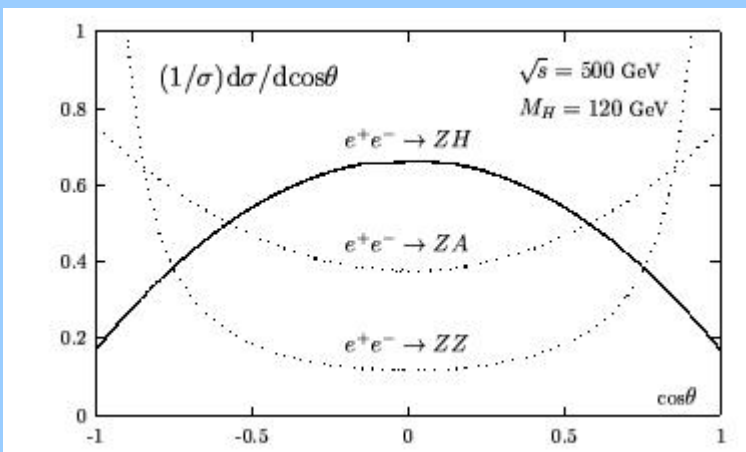

Also $e^+e^- \rightarrow e^+e^-Z$
Han, Jiang

Is This the Standard Model Higgs?

1.) Does the hZZ coupling saturate the Z coupling sum rule?

$$\Sigma g_{hZZ} = M_Z^2 g_{ew}^2 / 4 \cos^2 \theta_W$$

eg. $g_{hZZ} = g_Z M_Z \sin(\beta - \alpha)$

$$g_{HZZ} = g_Z M_Z \cos(\beta - \alpha)$$

$$g_Z = g_{ew} / 2 \cos \theta_W$$

2.) Are the measured BRs consistent with the SM?

eg. $g_{hbb}^{MSSM} = g_{hbb} (-\sin \alpha / \cos \beta) \rightarrow -g_{hbb} (\sin(\beta - \alpha) - \cos(\beta - \alpha) \tan \beta)$

$$g_{h\tau\tau}^{MSSM} = g_{h\tau\tau} (-\sin \alpha / \cos \beta) \rightarrow -g_{h\tau\tau} (\sin(\beta - \alpha) - \cos(\beta - \alpha) \tan \beta)$$

$$g_{htt}^{MSSM} = g_{htt} (-\cos \alpha / \sin \beta) \rightarrow g_{htt} (\sin(\beta - \alpha) + \cos(\beta - \alpha) / \tan \beta)$$

(in MSSM only for smaller values of M_A will there be sensitivity, since $\sin(\beta - \alpha) \rightarrow 1$ as M_A grows -decoupling)

3.) Is the width consistent with SM?

4.) Have other Higgs bosons or super-partners been discovered?

5.) et c.

Is This the Standard Model Higgs?

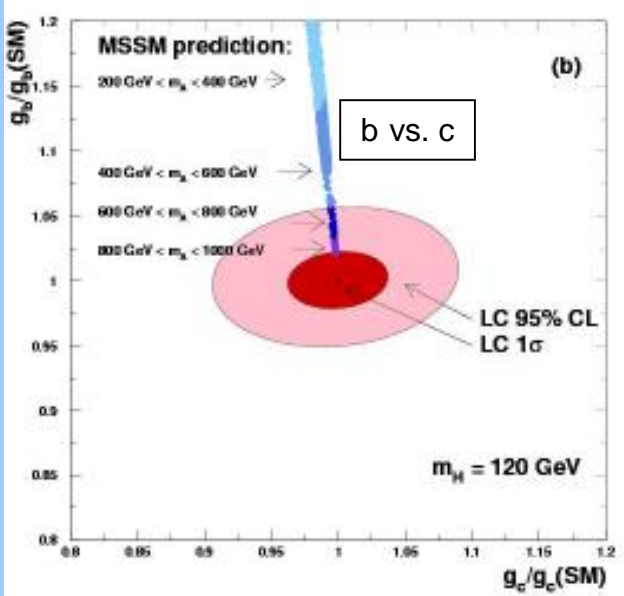
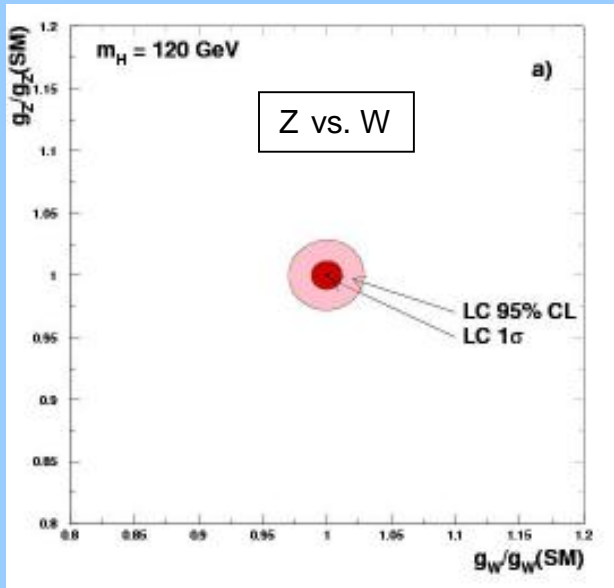

Arrows at:
 $M_A = 200-400$
 $M_A = 400-600$
 $M_A = 600-800$
 $M_A = 800-1000$

HFI TTER out put

conclusion:
 for $M_A < 600$,
 likely distinguish

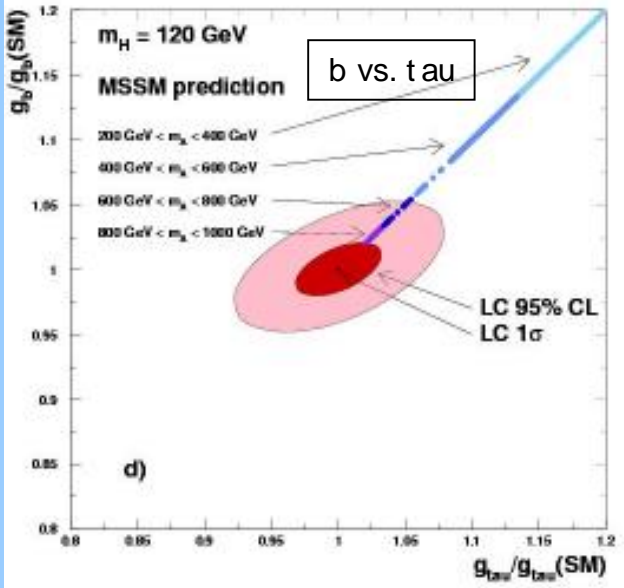
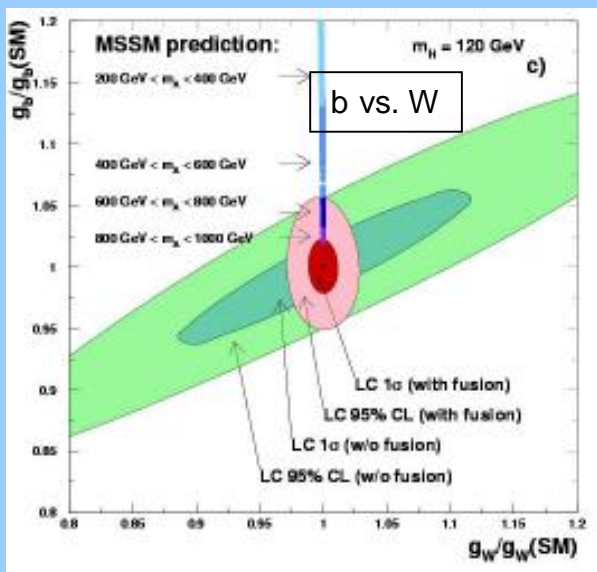

Other scenarios

- Super symmetry
 - all particles matched by super-partners
 - super-partners of fermions are bosons
 - super-partners of bosons are fermions
 - inspired by string theory
 - high energy cancellation of divergences
 - could play role in dark matter problem
 - many new particles (detailed properties only at NLC)
- Extra Dimensions
 - string theory predicts
 - solves hierarchy ($M_{\text{planck}} > M_{\text{EW}}$) problem if extra dimensions are large (or why gravity is so weak)
 - large extra dimensions would be observable at NLC (see Physics Today, February 2002)

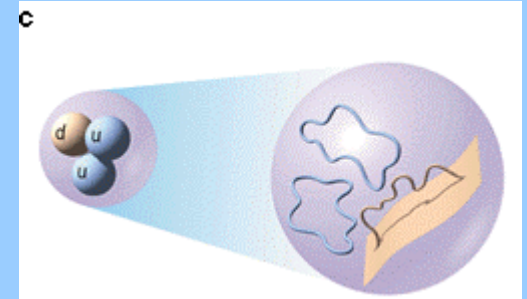

Large Extra Dimensions

- In addition to the three infinite spatial dimensions we know about, it is assumed there are n new spatial dimensions of finite extent R
- Some of the extra dimensions could be quite large
- The experimental limits on the size of extra dimensions are not very restrictive
 - to what distance has the $1/r^2$ force law been measured?
 - extra dimensions could be as large as 0.1 mm, for example
 - experimental work is under way now to look for such large extra dimensions

Large Extra Dimensions

- Particles and the Electroweak and Strong interactions are confined to 3 space dimensions
- Gravity is different:
 - Gravitons propagate in the full $(3 + n)$ -dimensional space
- If there were only one large extra dimension, its size R would have to be of order 10^{10} km to account for the weakness of gravity.
- But two extra dimensions would be on the order of a millimeter in size.
- As the number of the new dimensions increases, their required size gets smaller.
 - For six equal extra dimensions, the size is only about 10^{-12} cm

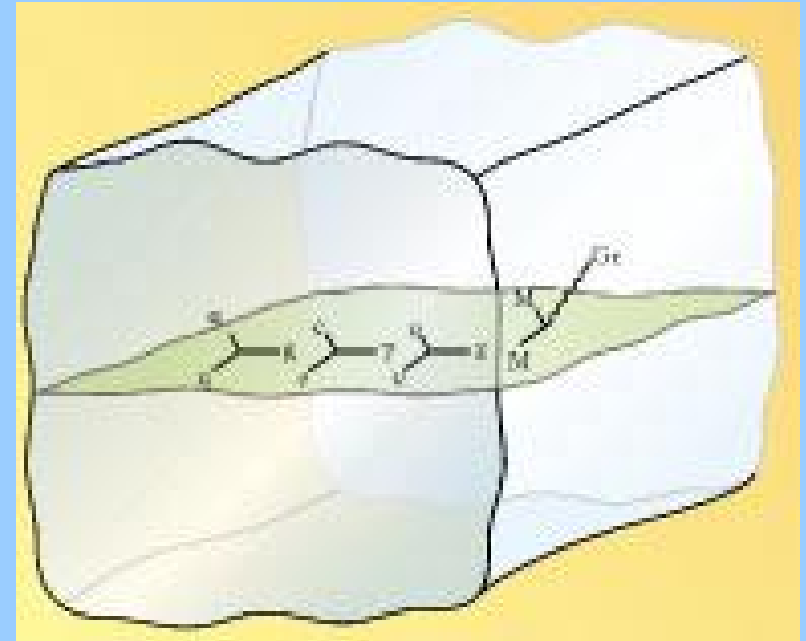

(see Large Extra Dimensions: A New Arena for Particle Physics, Nima Arkani-Hamed, Savas Dimopoulos, and Georgi Dvali, Physics Today, February, 2002)

Explaining the weakness of gravity

Cosmic connections

- Big Bang Theory
- GUT motivated inflation
- dark matter
- accelerating universe
- dark energy

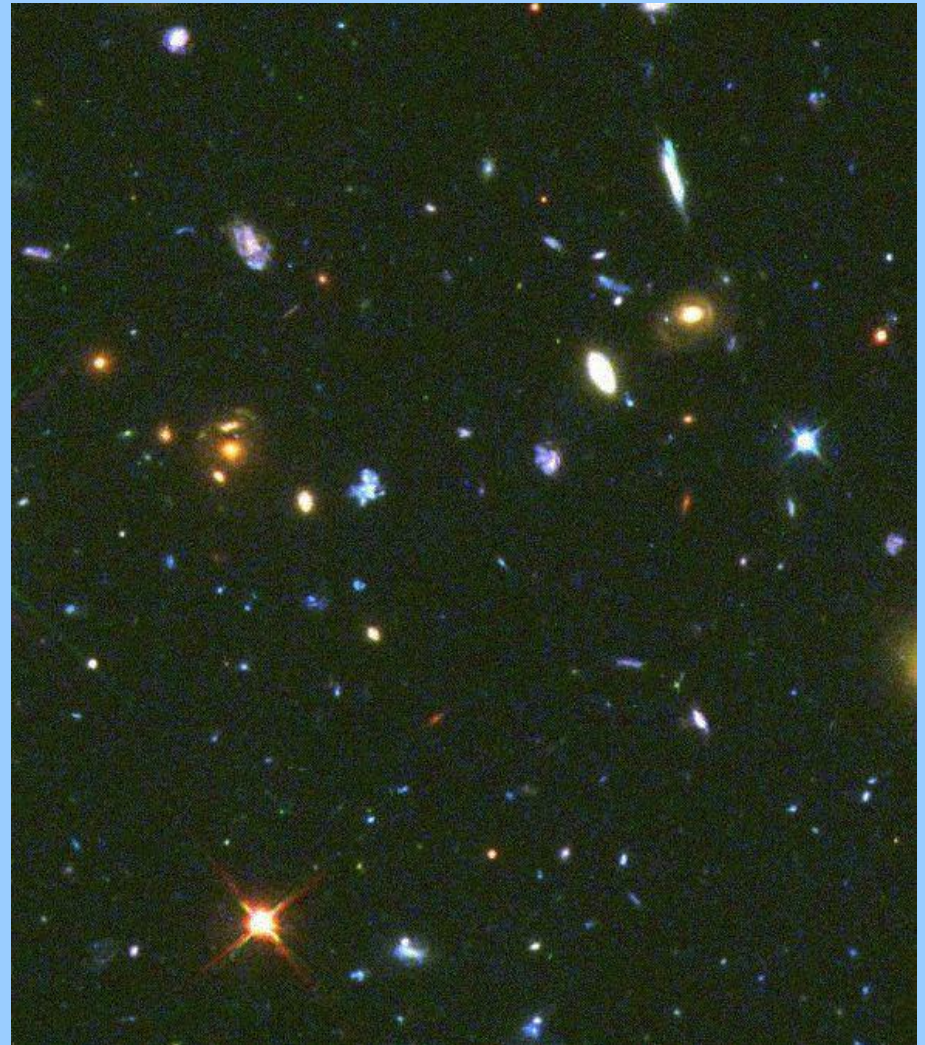

The Large Hadron Collider (LHC)

- The LHC at CERN, colliding proton beams, will begin operation around 2007
- This “hadron-collider” is a discovery machine, as the history of discoveries show

<u>discovery</u>	<u>facility of discovery</u>	<u>facility of study</u>
charm	BNL + SPEAR	SPEAR at SLAC
tau	SPEAR	SPEAR at SLAC
bottom	Fermilab	Cornell
Z^0	SPPS	LEP and SLC

- The “electron-collider” (the NLC) will likely be needed to sort out the LHC discoveries

Adding Value to LHC measurements

The Linear Collider will add value to the LHC measurements (“enabling technology”)

How this happens depends on the Physics:

- Add precision to the discoveries of LHC
 - eg. light higgs measurements
- Susy parameters may fall in the tan β / M_A wedge.
- Directly observed strong WW/ZZ resonances at LHC are understood from asymmetries at Linear Collider
- Analyze extra neutral gauge bosons
- Giga-Z constraints

Complementarity with LHC

The SM-like Higgs Boson

	M_H (GeV)	$\delta(X)/X$ LHC $2 \times 300 \text{ fb}^{-1}$	$\delta(X)/X$ LC 500 fb^{-1}
M_H	120	9×10^{-4}	3×10^{-4}
M_H	160	10×10^{-4}	4×10^{-4}
Γ_{tot}	120-140	-	$0.04 - 0.06$
$g_{Hu\bar{u}}$	120-140	-	$0.02 - 0.04$
$g_{Hd\bar{d}}$	120-140	-	$0.01 - 0.02$
g_{HWWW}	120-140	-	$0.01 - 0.03$
$\frac{g_{Hu\bar{u}}}{g_{Hd\bar{d}}}$	120-140	-	$0.023-0.052$
$\frac{g_{Hd\bar{d}}}{g_{HWWW}}$	120-140	-	$0.012-0.022$
$\frac{g_{Hu\bar{u}}}{g_{HWWW}}$	120	0.070	0.023
$\frac{g_{Hd\bar{d}}}{g_{HWWW}}$	160	0.050	0.022
CP test	120	-	0.03
λ_{HHH}	120	-	0.22

These precision measurements will be crucial in understanding the Higgs Boson

TESLA TDR, Table 2.5.1

Table 2.5.1: Comparison of the expected accuracy in the determination of the SM-like Higgs profile at the LHC and at TESLA. The mass, width, couplings to up-type and down-type quarks and to gauge bosons, several of the ratios of couplings, the triple Higgs coupling and the sensitivity to a CP-odd component are considered.

Conclusion

The Linear Collider will be a powerful tool for studying the Higgs Mechanism and Electroweak Symmetry Breaking.

This physics follows a century of unraveling the theory of the electroweak interaction

We can expect these studies to further our knowledge of fundamental physics in unanticipated ways

Current status of Electroweak Precision measurements strongly suggests that the physics at the LC will be rich

Higgs Studies - the Mass Measurement

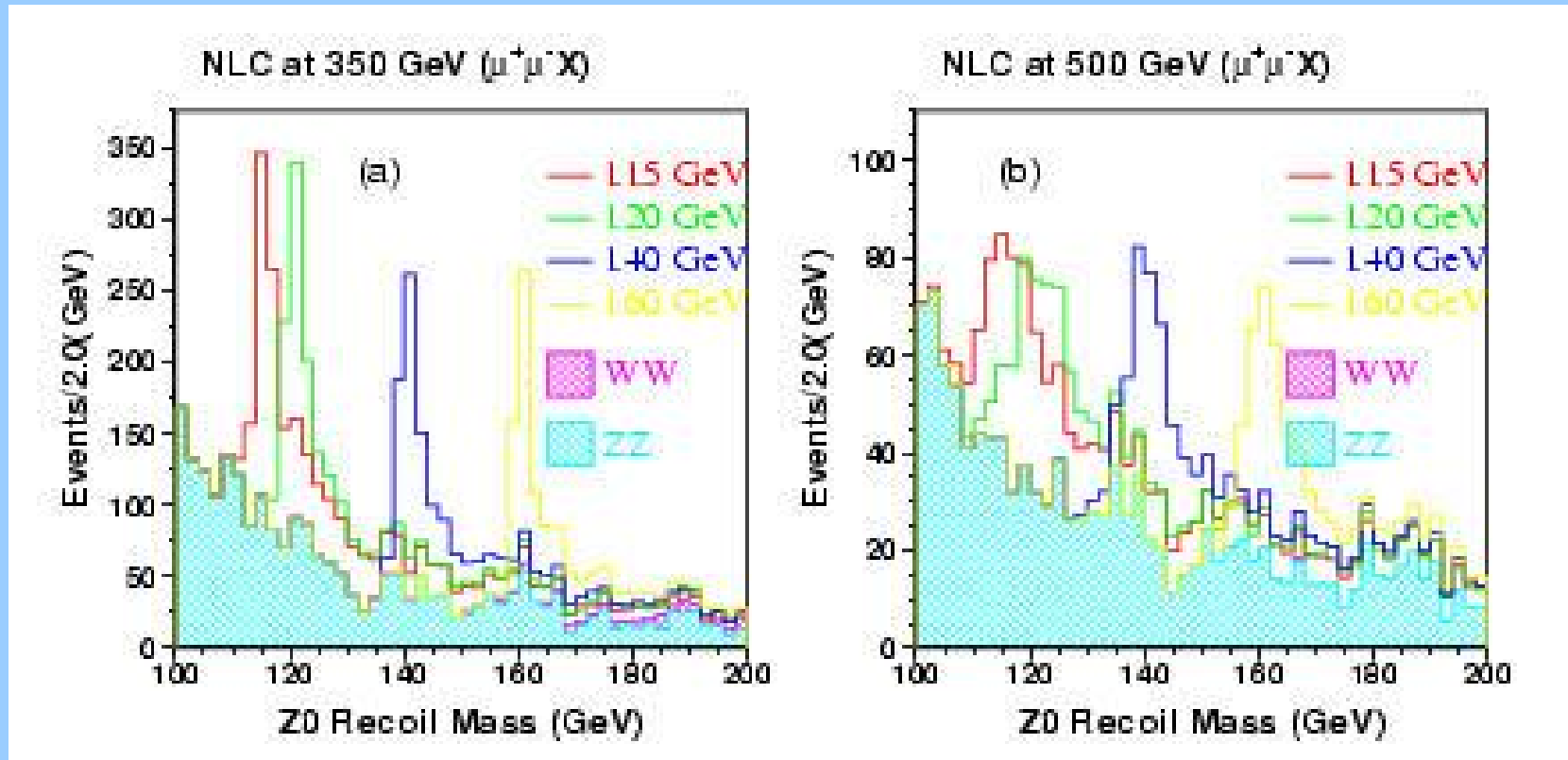

500 fb⁻¹, LC Physics Resource Book, Fig. 3.17

($m=120$ GeV @ 500 GeV) $\delta M/M \sim 1.2 \times 10^{-3}$ from recoil alone (decay mode indep.), but reconstruction of Higgs decay products and fit does even better.....

Is This the Standard Model Higgs?

For $M_H = 140 \text{ GeV}$, 500 fb^{-1} @ 500 GeV

Mass Measurement

$$\delta M_H \approx 60 \text{ MeV} \approx 5 \times 10^{-4} M_H$$

Total width

$$\delta \Gamma_H / \Gamma_H \approx 3 \%$$

Particle couplings

$t\bar{t}$

(needs higher \sqrt{s} for 140 GeV ,
except through $H \rightarrow gg$)

$b\bar{b}$

$$\delta g_{Hbb} / g_{Hbb} \approx 2 \%$$

$c\bar{c}$

$$\delta g_{Hcc} / g_{Hcc} \approx 22.5 \%$$

$\tau^+\tau^-$

$$\delta g_{H\tau\tau} / g_{H\tau\tau} \approx 5 \%$$

WW

$$\delta g_{Hww} / g_{Hww} \approx 2 \%$$

ZZ

$$\delta g_{HZZ} / g_{HZZ} \approx 6 \%$$

gg

$$\delta g_{Hgg} / g_{Hgg} \approx 12.5 \%$$

$\gamma\gamma$

$$\delta g_{H\gamma\gamma} / g_{H\gamma\gamma} \approx 10 \%$$

Spin-parity-charge conjugation

establish $J^{PC} = 0^{++}$

Self-coupling

$$\delta \lambda_{HHH} / \lambda_{HHH} \approx 32 \%$$

(statistics limited)

Is This the Standard Model Higgs?

Are the measured BRs consistent with the SM?
 (only for smaller values of M_A will there be sensitivity -decoupling)



M. Carena, H.E. Haber, H.E. Logan, and S. Mrenna, FERMILAB-Pub-00/334-T

