

Designing a Detector for Linear Collider Physics

Jim Brau
University of Oregon

Aspen Winter Conference

January 12, 2007

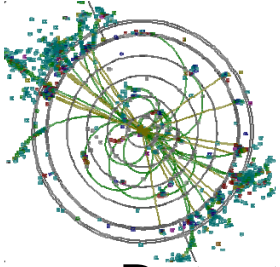

Detector for the International Linear Collider

Detector Requirements are defined by
ILC machine parameters
physics goals

ILC creates new challenges and opportunities,
different in many respects from the challenges and
opportunities of the LHC detectors

Physics motivates

Triggerless event collection (software event selection)

Extremely precise vertexing

Synergistic design of detectors components:

vertex detector, tracker, calorimeters integrated for optimal jet
reconstruction

Advanced technologies based on recent detector innovations

Detector R&D to optimize ILC opportunity is critically needed

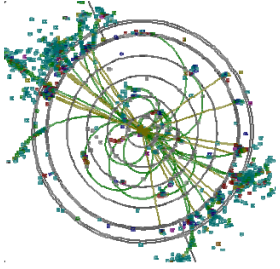

ILC Physics Goals



- EWSB
 - Higgs
 - Mass (~ 50 MeV at 120 GeV)
 - Width
 - BRs (at the few% level)
 - Quantum Numbers (spin/parity)
 - Self-coupling
 - Strong coupling (virtual sensitivity to several TeV)
- SUSY particles
 - Strong on sleptons and neutralinos/charginos
- Extra dimensions
 - Sensitivity through virtual graviton
- Top
 - Mass measured to ~ 100 MeV (threshold scan)
 - Yukawa coupling
- W pairs
 - W mass

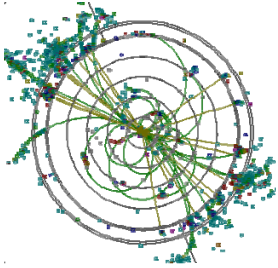

Power of Constrained Initial State + Simple Reactions

- Well defined initial state
- Democratic interactions

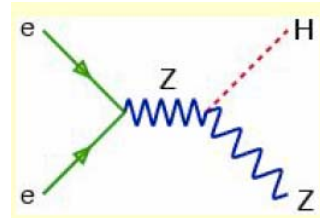

Higgs recoiling from a Z, with known CM energy \downarrow , provides a powerful channel for unbiased tagging of Higgs events, allowing measurement of even invisible decays (\downarrow - some beamstrahlung)

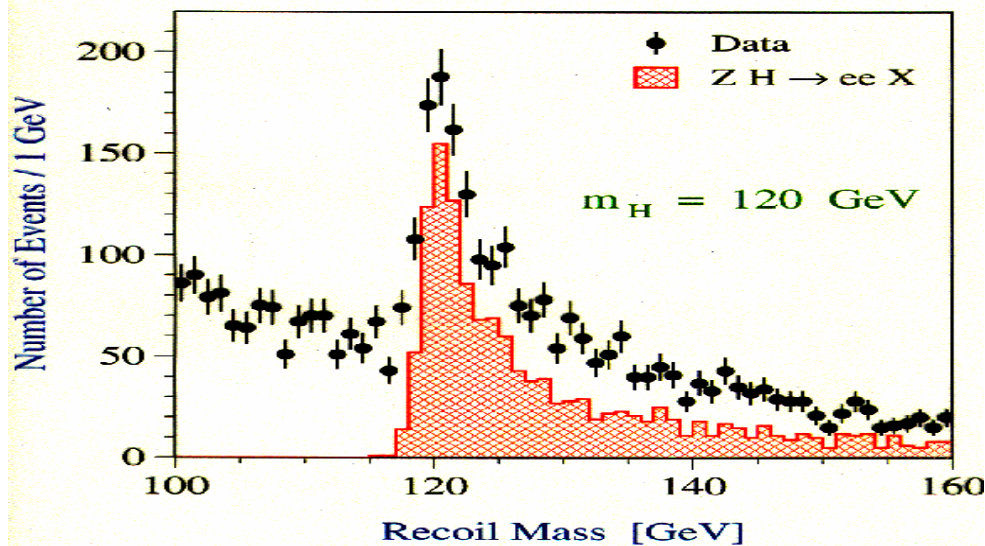

500 fb⁻¹ @ 500 GeV, TESLA TDR, Fig 2.1.4

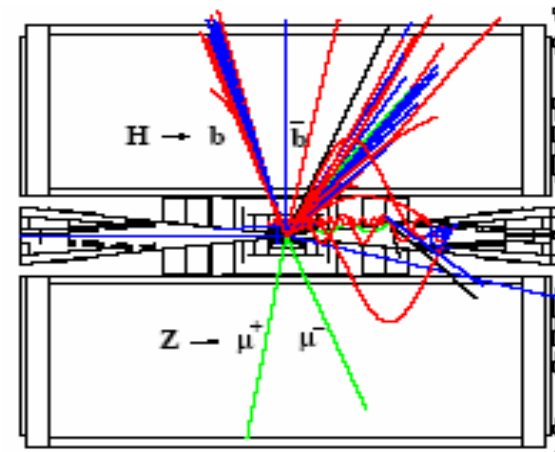

Demands Precise Tracking

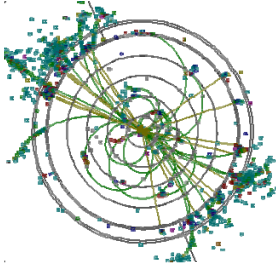

Effect of Tracking Resolution

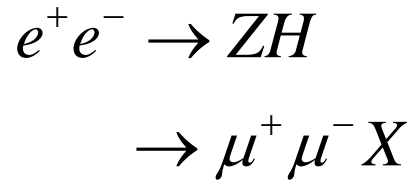

$$\sqrt{s} = 350 \text{ GeV}$$

$$L = 500 \text{ fb}^{-1}$$

$$\frac{\delta p_t}{p_t^2} = a \oplus \frac{b}{p_t \sin \theta}$$

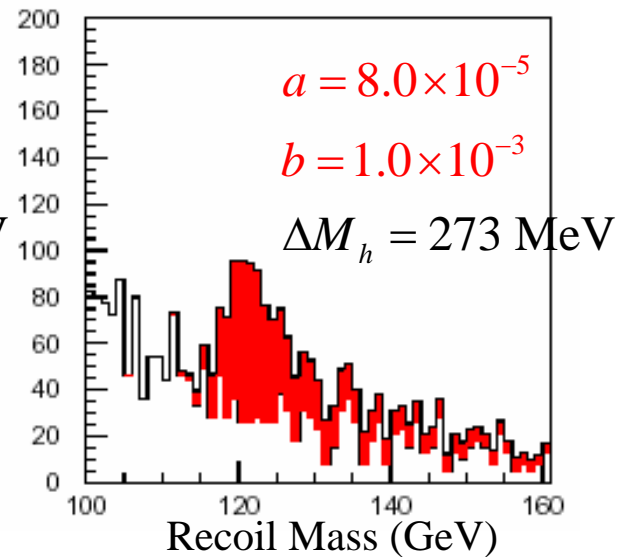
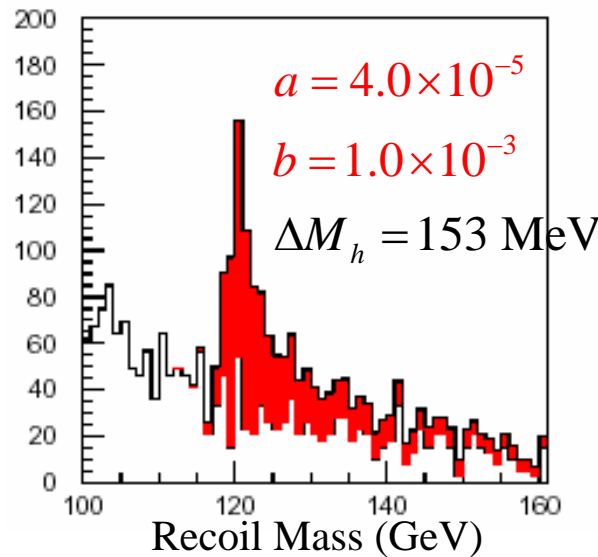
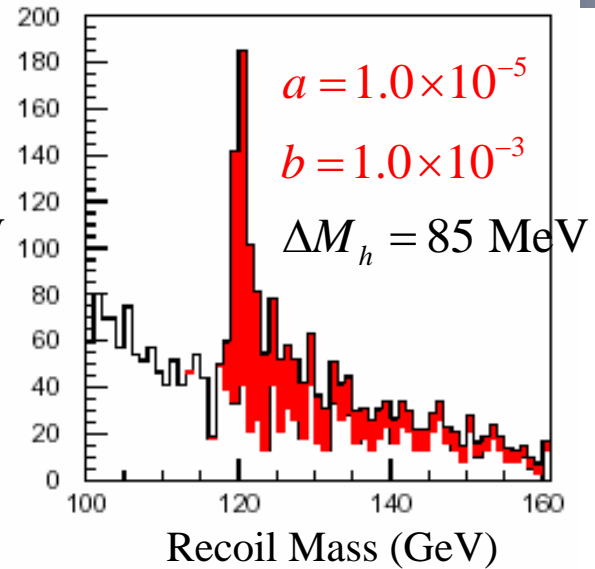
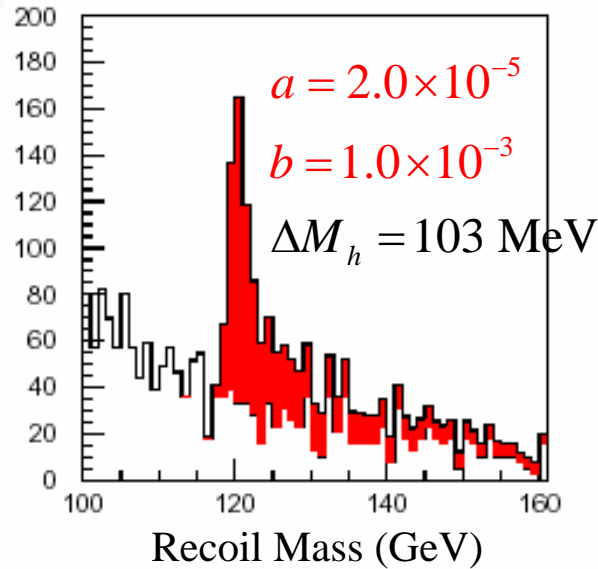

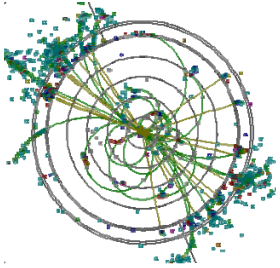

The Electroweak Precision Measurements Anticipate a Light Higgs – Then What?

- Measurement of BR's is powerful indicator of new physics
e.g. in MSSM, these differ from the SM in a characteristic way.
- Higgs BR must agree with MSSM parameters from many other measurements.

Vertex Detector

Impact Parameter Resolution

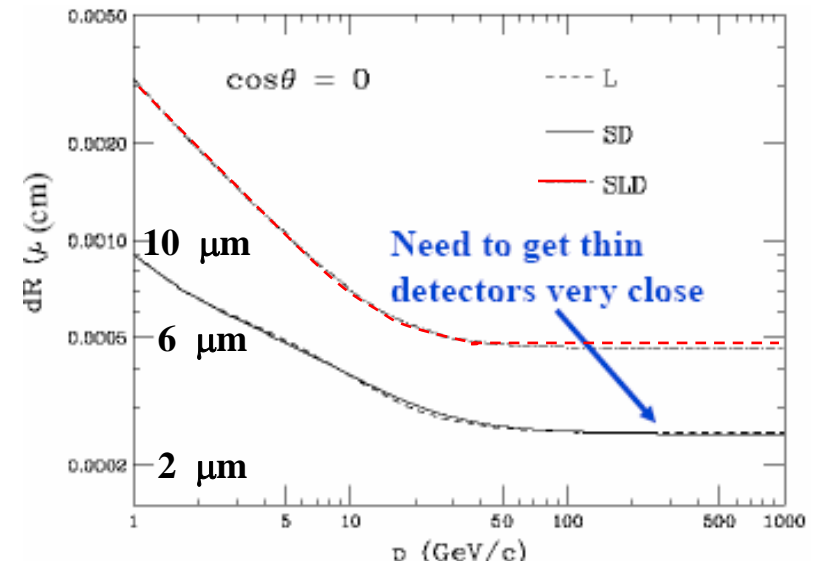
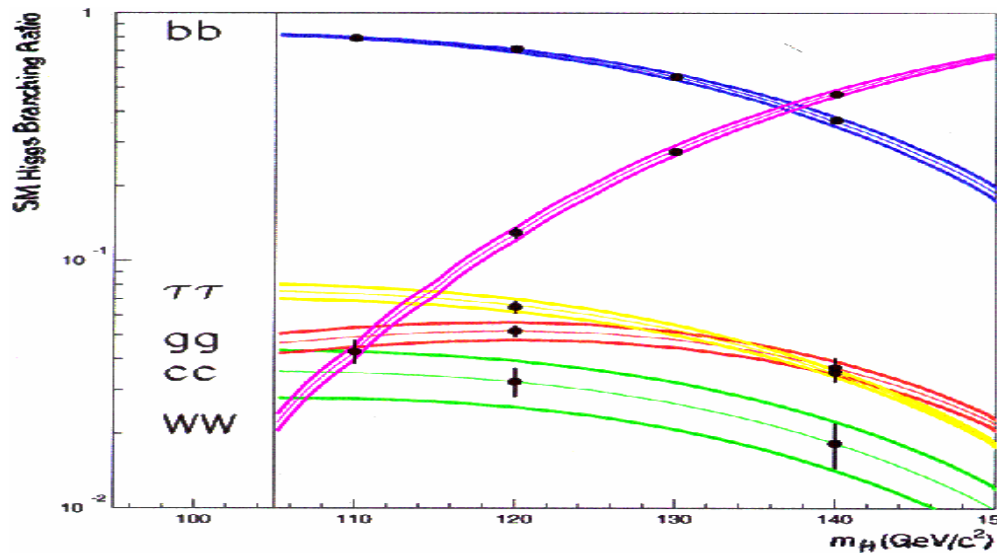

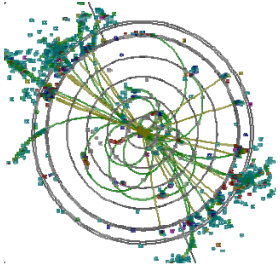

b vs. W

TESLA TDR, Fig 2.2.6

Arrows at:

- $M_A = 200-400$
- $M_A = 400-600$
- $M_A = 600-800$
- $M_A = 800-1000$

HFITTER output

conclusion:

for $M_A < 600$,
likely to distinguish

Is This the Standard Model Higgs?

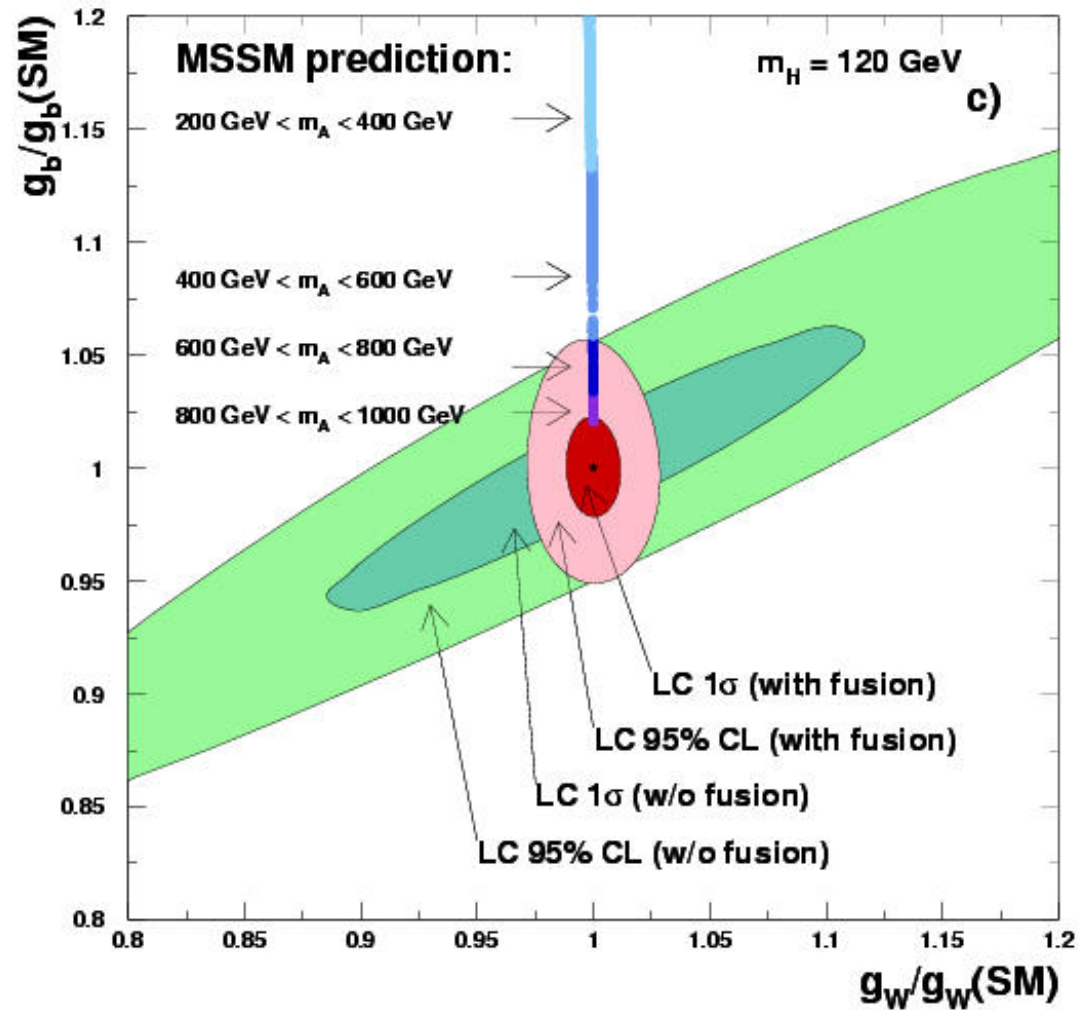

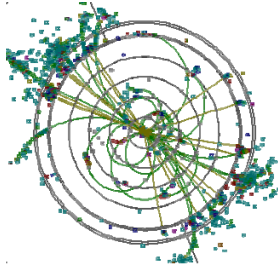

ILC Experimental Advantages



Elementary interactions at known E_{cm}^*

eg. $e^+e^- \rightarrow ZH$

* beamstrahlung manageable

Democratic Cross sections

eg. $\sigma(e^+e^- \rightarrow ZH) \sim 1/2 \sigma(e^+e^- \rightarrow d\bar{d})$

Inclusive Trigger

total cross-section

Highly Polarized Electron Beam

$\sim 80\%$ (+ positron polarization – R&D)

Exquisite vertex detection

eg. $R_{\text{beampipe}} \sim 1 \text{ cm}$ and $\sigma_{\text{hit}} \sim 3 \mu\text{m}$

Calorimetry with Particle Flow Precision

$\sigma_E/E \sim 30\text{-}40\%/\sqrt{E}$

Advantage over hadron collider on precision meas.

eg. $H \rightarrow c\bar{c}$

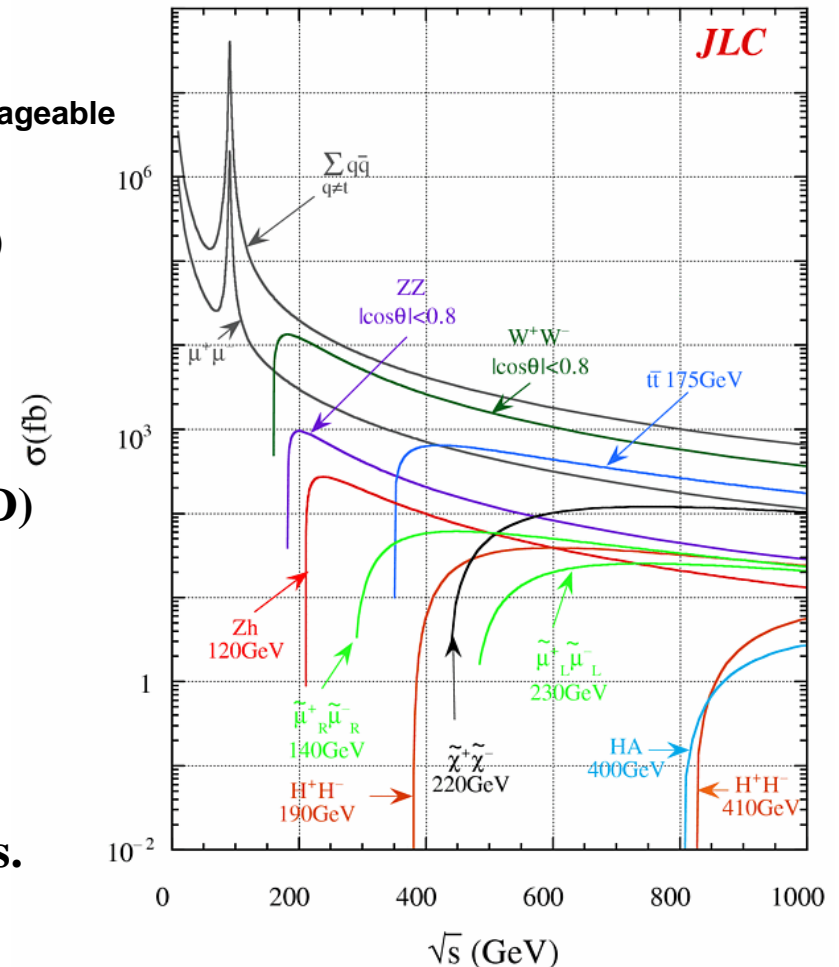

Detector performance translates directly into effective luminosity

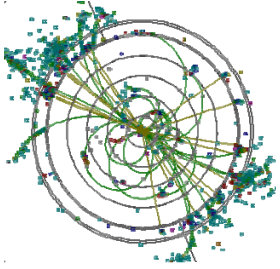

ILC Detector Requirements

- **Two-jet mass resolution** comparable to the natural widths of W and Z for an unambiguous identification of the final states.
- Excellent **flavor-tagging** efficiency and purity (for both b- and c-quarks, and hopefully also for s-quarks).
- Momentum resolution capable of reconstructing the **recoil-mass** to di-muons in Higgs-strahlung with resolution better than beam-energy spread.
- Hermeticity (both crack-less and coverage to very forward angles) to precisely determine the **missing momentum**.
- **Timing** resolution capable of separating bunch-crossings to suppress overlapping of events .

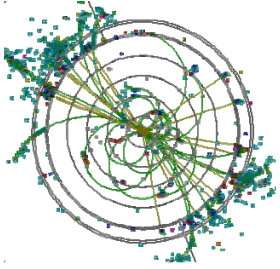

Detector R&D Required



- Performance requirements for ILC Detector exceed state-of-the-art
 - Calorimeters with ~100 million cells
 - Jet resolution goal $\sim 30\% / \sqrt{E}$
 - Pixel Vertex Detector with $\sim 10^9 \leq 20 \mu\text{m}$ pixels
 - Impact parameter resolution $5\mu\text{m} \oplus 10\mu\text{m}/(p \sin^{3/2}\theta)$
 - Sensitivity to full 1 msec bunchtrain
 - Tracking resolution $\sigma(1/p) \leq 5 \times 10^{-5} / \text{GeV}$
 - TPC
 - Silicon microstrips
 - High Field Solenoid ~ 5 Tesla
 - High quality forward tracking systems
 - Triggerless readout

- R&D Essential

DISCOVERY OPPORTUNITY IS GREAT

- limited by detector performance

small cross sections/significant backgrounds

- advances different from LHC required

Collider Parameters

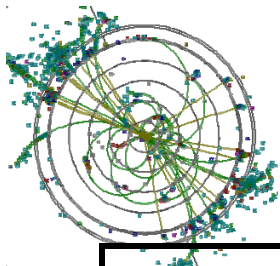

Machine parameter	value
#bunches/train	2820
#trains/sec	5
bunch spacing	308 nsec
bunches/sec	14100
length of train	868 μ sec
train spacing	199 msec
crossing angle	2-14 mrad
Luminosity	$2 \times 10^{34} \text{ cm}^{-2} \text{ s}^{-1}$

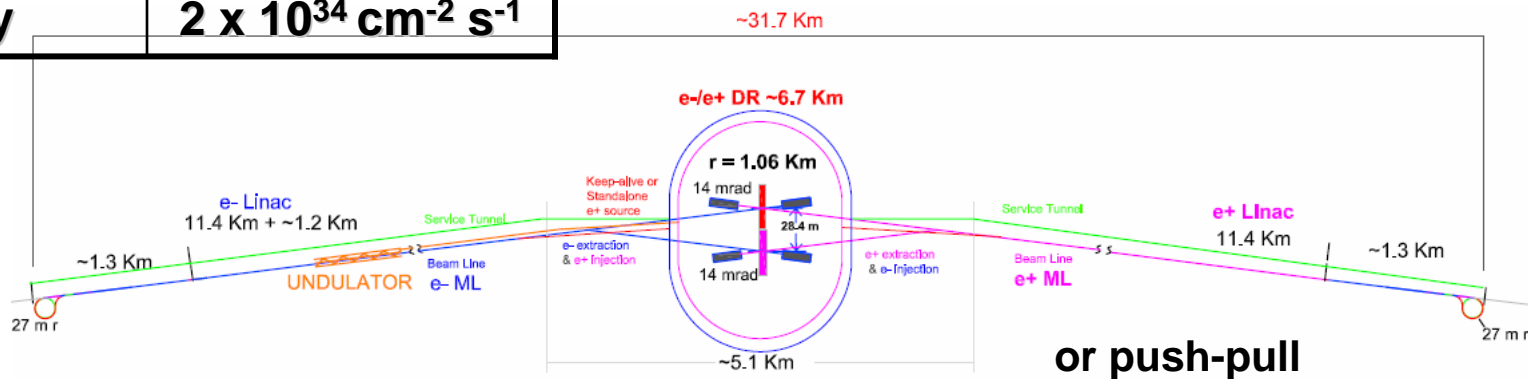
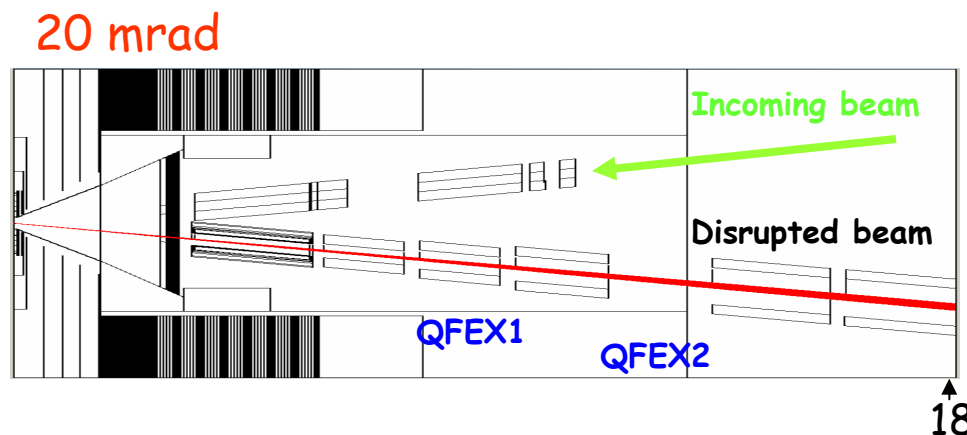
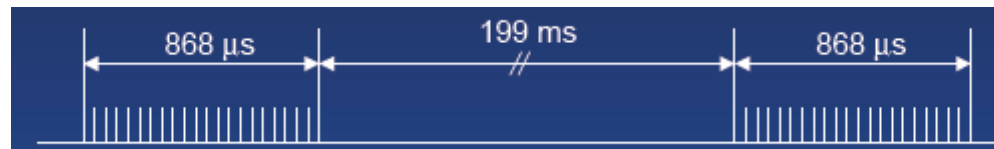

Background Sources

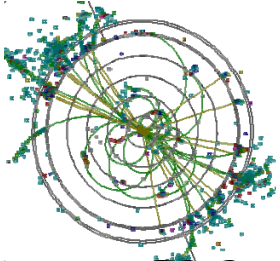

IP Backgrounds

- Beam-beam Interactions
 - ↖ Disrupted primary beam
 - ❖ Extraction line losses
 - ↖ Beamstrahlung photons
 - ↖ e^+e^- pairs
- Radiative Bhabhas
- $\gamma\gamma \rightarrow \text{hadrons}/\mu^+\mu^-$

Somewhat manageable -

- Scale with luminosity
- Transport them away from IP
- Shield sensitive detectors
- Exploit detector timing
- **Reliable simulations.**

Machine backgrounds

- Muon production at collimators
- Collimator edge scattering
- Beam-gas
- Synchrotron radiations
- Neutrons from dumps/extr. line

Harder to handle -

- Don't make them
- Keep them from IP if you do
- **Dominated by beam halo**
- **Dependent on assumptions**

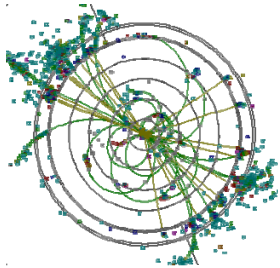

VXD background hits

- Pair background hit rate on the 1st layer of the Vertex Detector (R=24mm)
- Simulation using CAIN and JUPITER
- Hit rate of the Low Q option is $\sim 1/3$ of the nominal option, as expected

Pair B.G. hit rate (/cm ² /bunch)		
B(tesla)	Nominal	LowQ
3	0.488	0.149
4	0.48	0.113
5	0.183	0.069

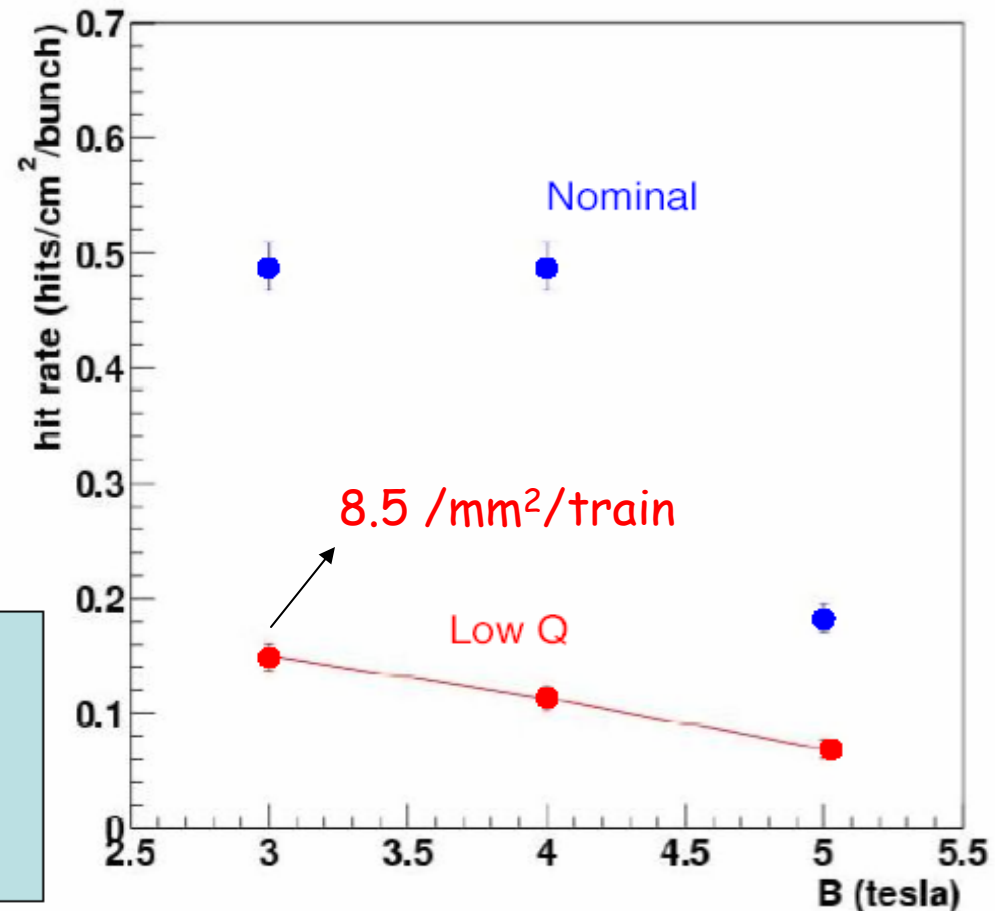

GLD study

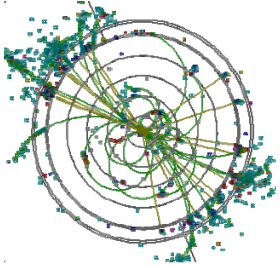

Event Rates and Backgrounds

○ Event rates (Luminosity = 2×10^{34})

- ↗ $e^+e^- \rightarrow qq, WW, tt, HX$
 - ❖ ~ 0.1 event / train
- ↗ $e^+e^- \rightarrow e^+e^- \gamma\gamma \rightarrow e^+e^- X$
 - ❖ ~ 200 /train

○ Background

- ↗ $6 \times 10^{10} \gamma$ / BX (from synchrotron radiation, scatters into central detector)
- ↗ 40,000-250,000 e^+e^- / BX (90-1000 TeV) @ 500 GeV
- ↗ Muons: < 1 Hz/cm² (w/ beamline spoilers)
- ↗ Neutrons: $\sim 3 \times 10^8$ /cm²/ yr @ 500 GeV

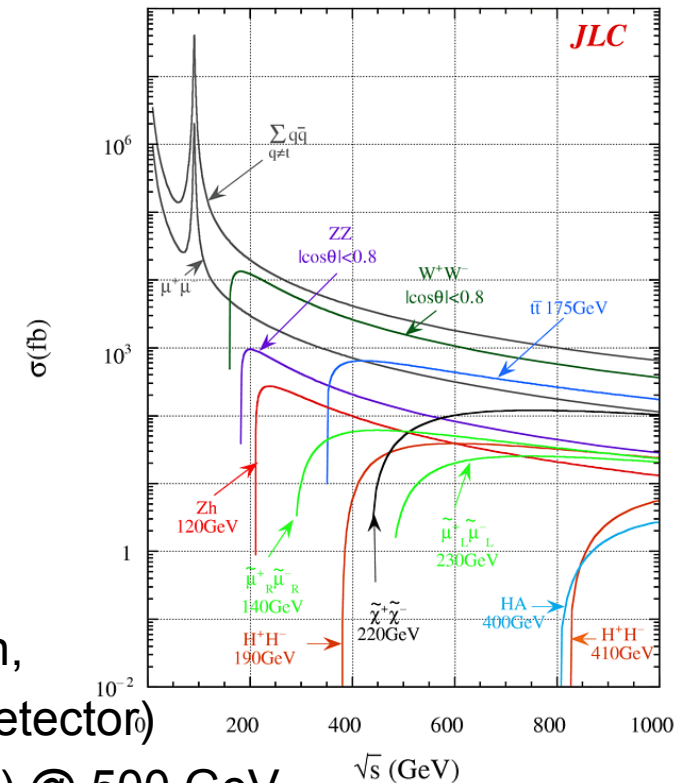

Ref: Maruyama, Snowmass 2005

Linear Collider Events

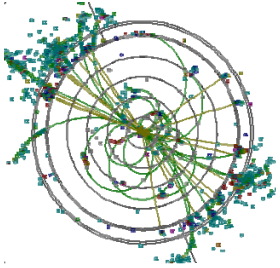

- Simple events (relative to Hadron collider) make particle level reconstruction feasible
- Heavy boson mass resolution requirement sets jet energy resolution goal

$$e^+e^- \rightarrow WW\nu\bar{\nu}, \quad e^+e^- \rightarrow ZZ\nu\bar{\nu}$$

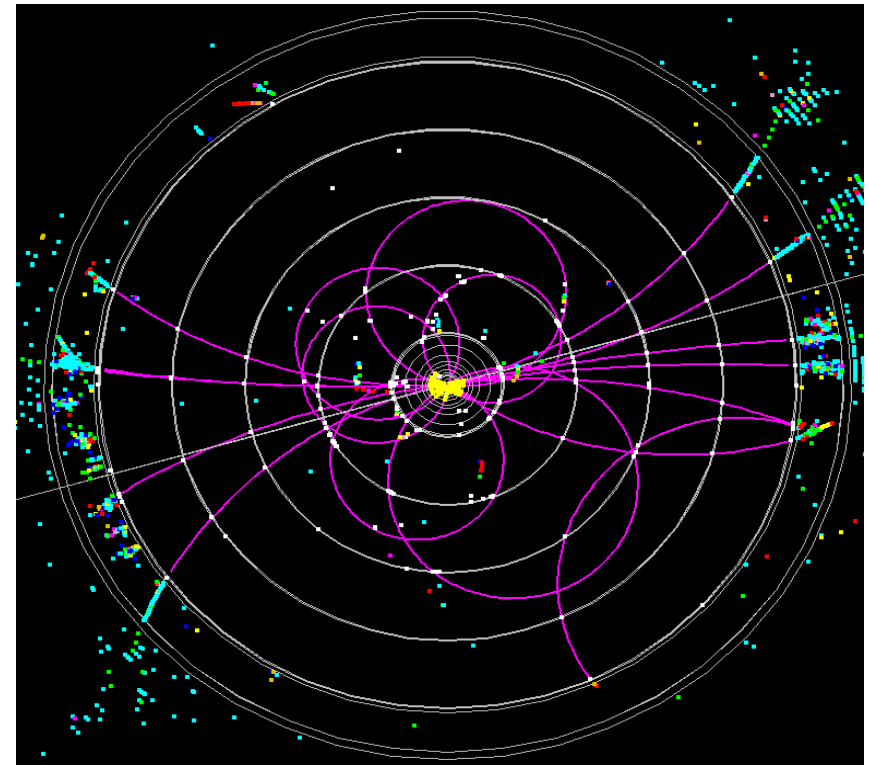

**This event shows
single bunch crossing in tracker,
150 bunches in the vertex detector**

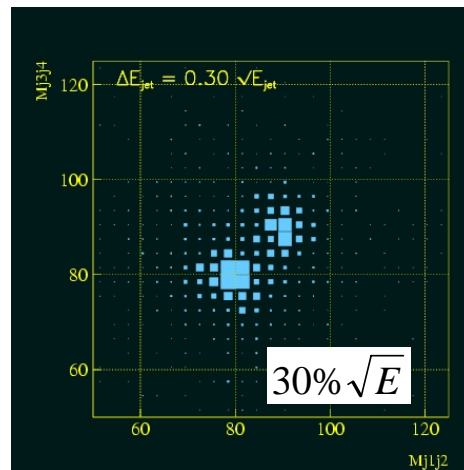
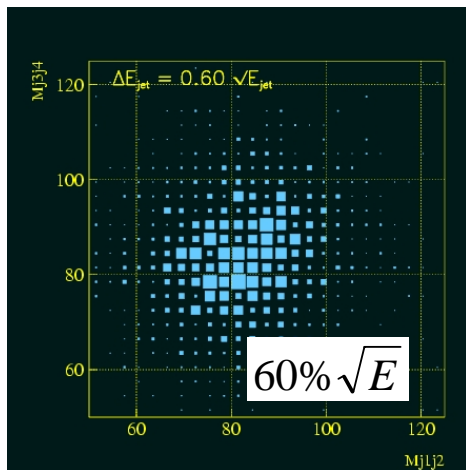

The Concepts

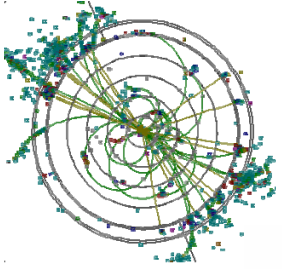

LDC

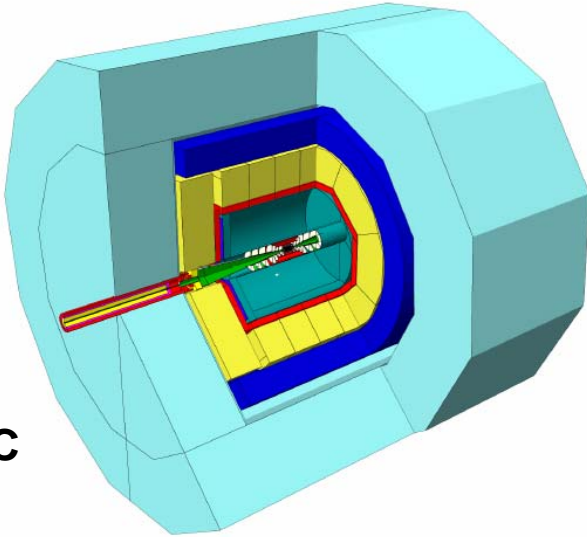

SiD

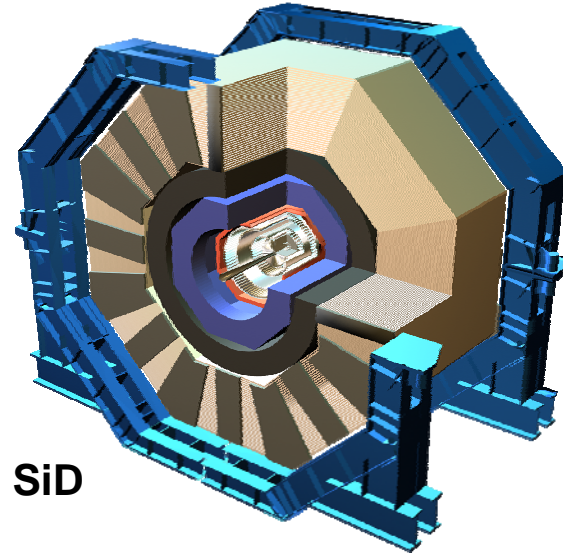

GLD

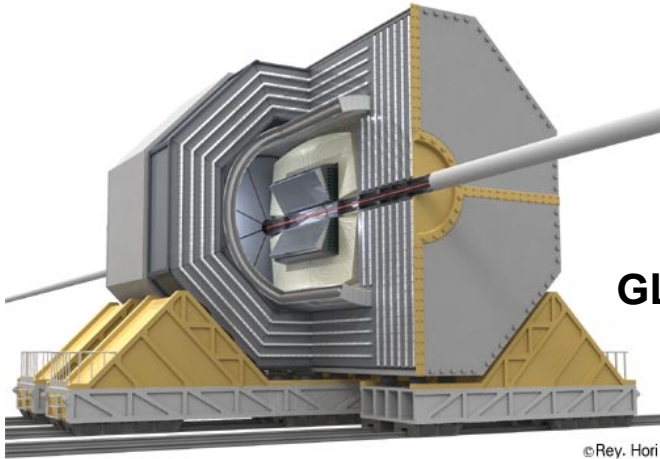

©Rev. Hori

4th

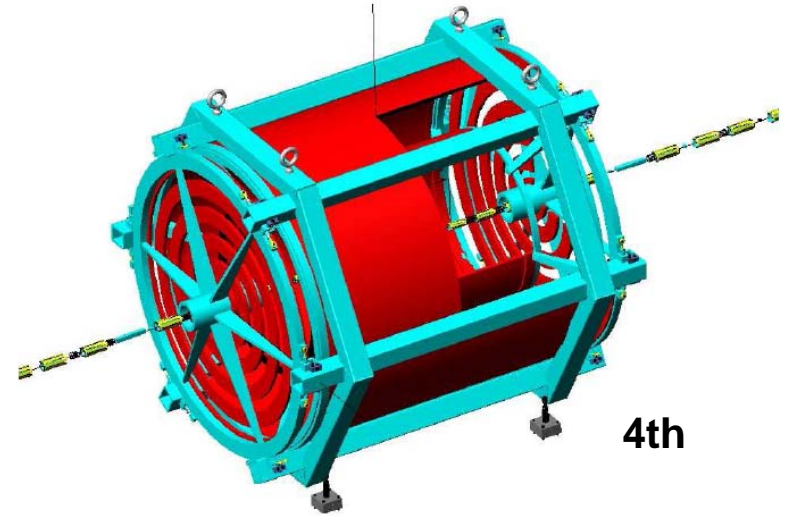

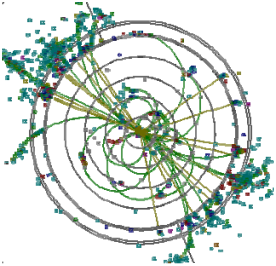

The Concepts

	Tracking	ECal Inner Radius	Solenoid	EM Cal	Hadron Cal	Other
SiD	silicon	1.27 m ↓	5 Tesla ↑	Si/W	Digital (RPC..)	Had cal inside coil
LCD	TPC gaseous	1.68 m ↓	4 Tesla ↑	Si/W	Digital or Analog	Had cal inside coil
GLD	TPC gaseous	2.1 m	3 Tesla	W/ Scin.	Pb/ Scin.	Had cal inside coil
4th	TPC gaseous			crystal	Compen- sating fiber	Double Solenoid (open mu)

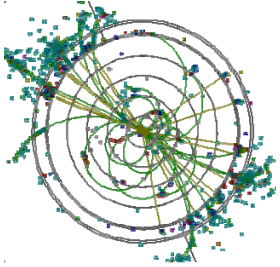

SiD (the Silicon Detector)

CALORIMETRY IS THE STARTING POINT IN THE SiD DESIGN

assumptions

- Particle Flow Calorimetry will result in the best possible performance
- Silicon/tungsten is the best approach for the EM calorimeter
- Silicon tracking delivers excellent resolution in smaller volume
- Large B field desirable to contain electron-positron pairs in beamline
- Cost is constrained

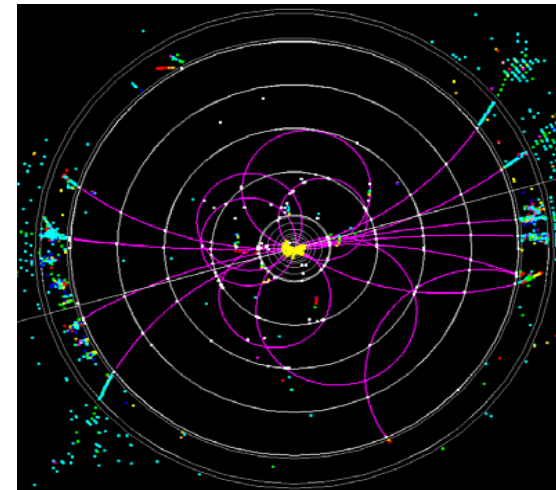

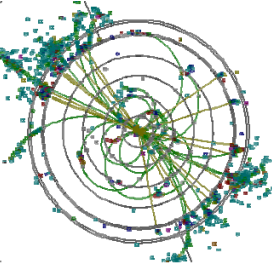

Calorimetry

Current paradigm: Particle Flow

- Jet resolution goal is $30\%/\sqrt{E}$
- In jet measurements, use the excellent resolution of tracker, which measures bulk of the energy in a jet

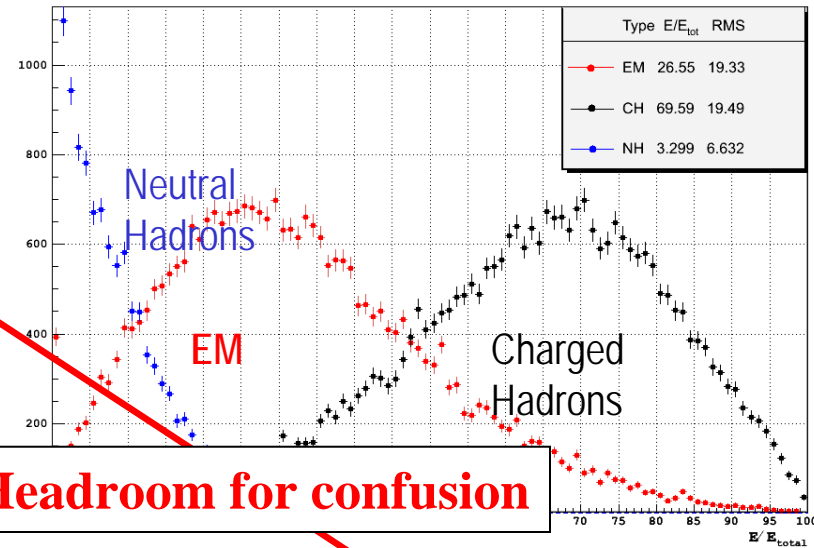

Headroom for confusion

Particles in Jet	Fraction of Visible Energy	Detector	Resolution
Charged	~65%	Tracker	< 0.005% p_T negligible
Photons	~25%	ECAL	~ 15% / \sqrt{E}
Neutral Hadrons	~10%	ECAL + HCAL	~ 60% / \sqrt{E}

< $20\% / \sqrt{E}$

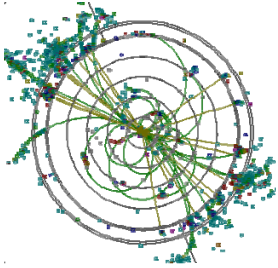

EM Calorimetry

- **Physics with isolated electron and gamma energy measurements require $\sim 10\text{-}15\%$ / $\sqrt{E} \oplus 1\%$**
- **Particle Flow Calorimetry requires fine grained EM calorimeter to separate neutral EM clusters from charged tracks entering the calorimeter**
 - ↗ **Small Moliere radius**
 - ❖ Tungsten
 - ↗ **Small sampling gaps – so not to spoil R_M**
 - ↗ **Separation of charged tracks from jet core helps**
 - ❖ Maximize BR^2
 - ↗ **Natural technology choice – Si/W calorimeters**
 - ❖ Good success using Si/W for Luminosity monitors at SLD, DELPHI, OPAL, ALEPH
 - ❖ Oregon/SLAC/BNL/Davis
 - ❖ CALICE Si/W

material	R_M
Iron	18.4 mm
Lead	16.5 mm
Tungsten	9.5 mm
Uranium	10.2 mm

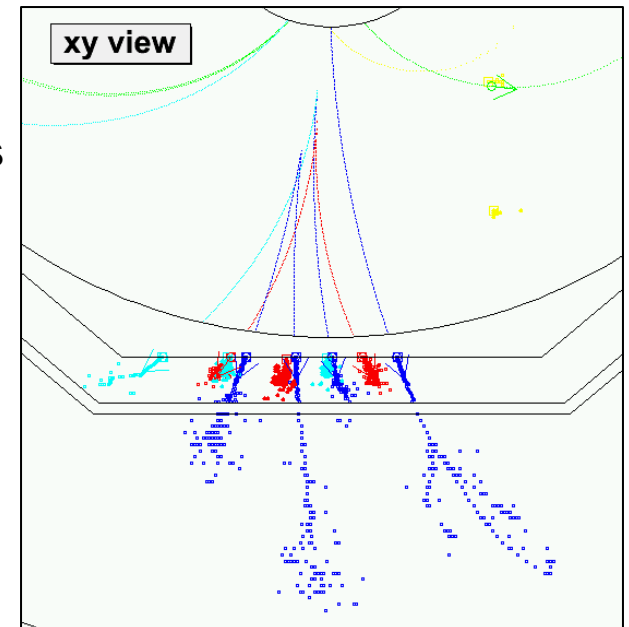

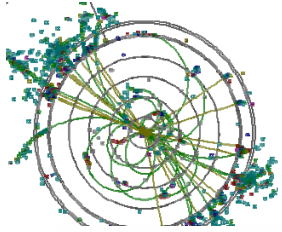

Silicon/Tungsten EM Calorimeter

Si-W Calorimeter Concept

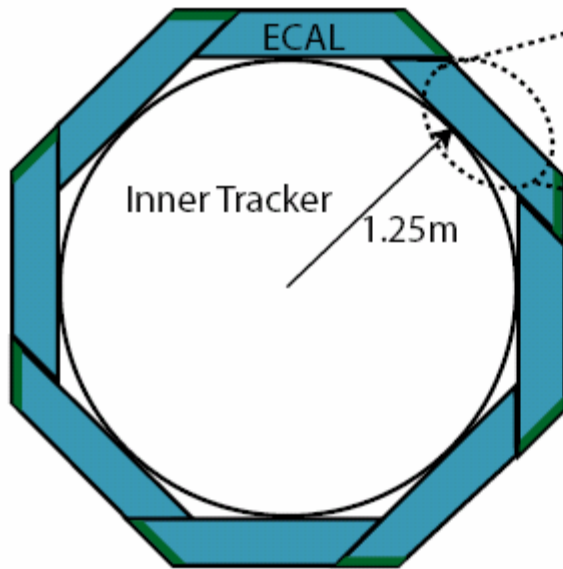

Transverse Segmentation ~ 3.5 mm
30 Longitudinal Samples
Energy Resolution $\sim 15\%/E^{1/2}$

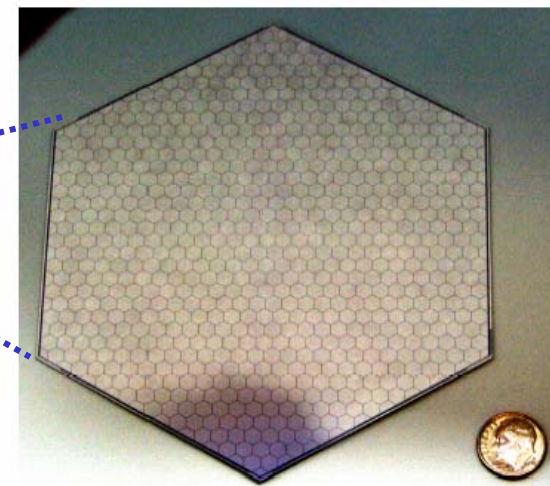
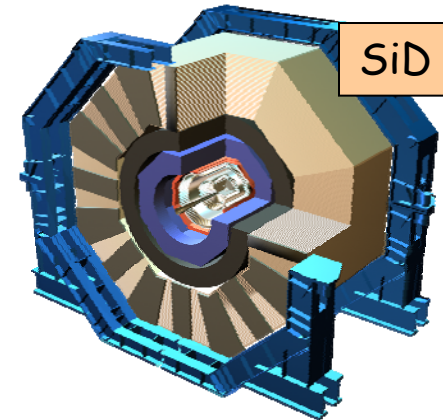
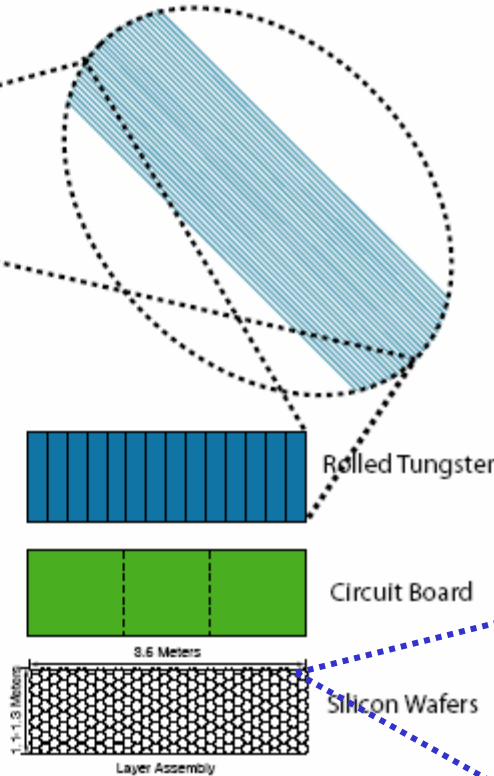

SLAC/Oregon/BNL/Davis/Annecy

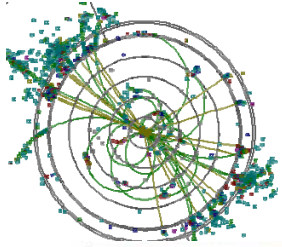

Silicon/Tungsten EM Calorimetry for ILC

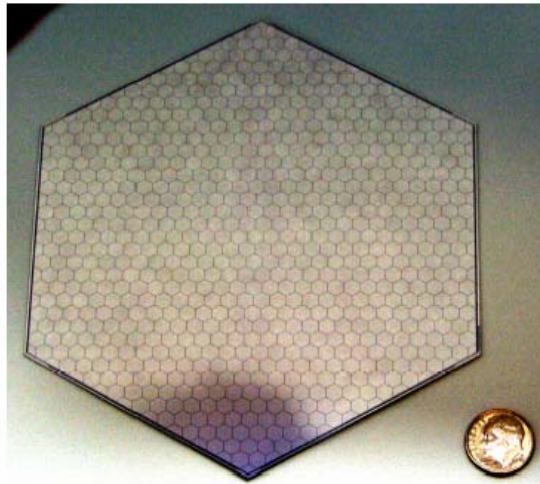
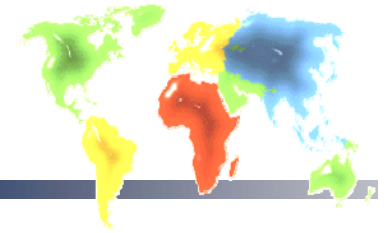

SLAC/Oregon/BNL/Davis/Annecy

Dense, fine grained silicon tungsten calorimeter (builds on SLC/LEP experience)

- Pads: 12 mm² to match Moliere r. (~ R_m/4)
- Each six inch wafer read out by one chip
- < 1% crosstalk

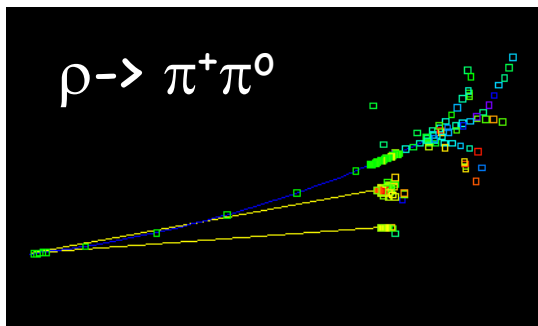
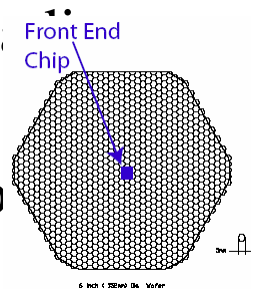

Electronics design

- Noise < 2000 electrons
- Si
- Dy
- cap

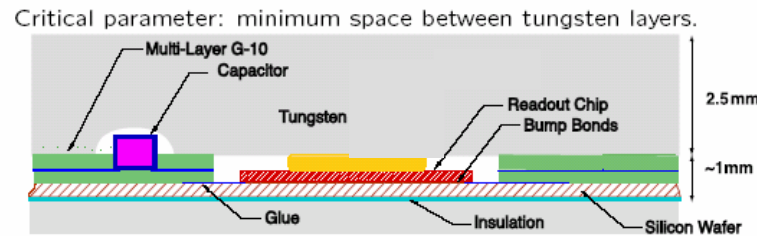

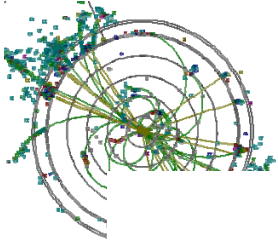

Hadron Calorimeter

Again Highly Segmented – for Particle Flow

M. Thomson

- Longitudinal: ~40 samples
- 4 – 5 λ (limited by cost - coil radius)
- Would like fine (1 cm² ?) lateral segmentation
- For 10000 m² of 1 cm² HCAL = 10⁸ channels – cost !

Two Main Options:

- ★ **Tile HCAL (Analogue readout)**
Steel/Scintillator sandwich
Lower lateral segmentation
~ 3x3 cm² (motivated by cost)
- ★ **Digital HCAL**
High lateral segmentation
~ 1x1 cm²
digital readout (granularity)
RPCs, wire chambers, GEMS...

OPEN QUESTION

The Digital HCAL Paradigm

- **Sampling Calorimeter:**
Only sample small fraction of the total energy deposition

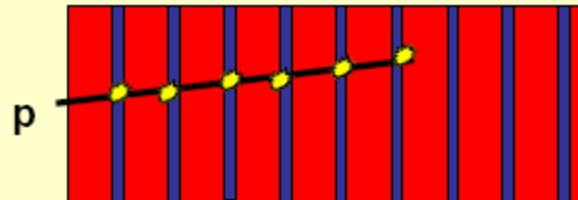

- **Energy depositions in active region follow highly asymmetric Landau distribution**

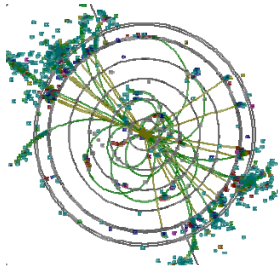

Hadron Calorimetry ($\sim 4\lambda$)

Options for Digital HCal: SS or Tungsten / 3 readout technologies

	Scintillator	GEMs	RPCs
Technology	Proven (SiPM?)	Relatively new	Relatively old
Electronic readout	Analog (multi-bit) or Semi-digital (few-bit)	Digital (single-bit)	Digital (single-bit)
Thickness (total)	$\sim 8\text{mm}$	$\sim 8\text{ mm}$	$\sim 8\text{ mm}$
Segmentation	$3 \times 3\text{ cm}^2$	$1 \times 1\text{ cm}^2$	$1 \times 1\text{ cm}^2$
Pad multiplicity for MIPs	Small cross talk	Measured at 1.27	Measured at 1.6
Sensitivity to neutrons (low energy)	Yes	Negligible	Negligible
Recharging time	Fast	Fast?	Slow (20 ms/cm^2)
Reliability	Proven	Sensitive	Proven (glass)
Calibration	Challenge	Depends on efficiency	Not a concern (high efficiency)
Assembly	Labor intensive	Relatively straight forward	Simple
Cost	Not cheap (SiPM?)	Expensive foils	Cheap

J. Repond

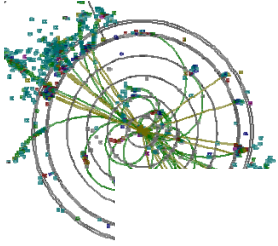

Calorimeter Reconstruction

- ★ High granularity calorimeters – very different to previous detectors (except LEP lumi. calorimeters)
- ★ “Tracking calorimeter” – requires a new approach to ECAL/HCAL reconstruction

+PARTICLE FLOW

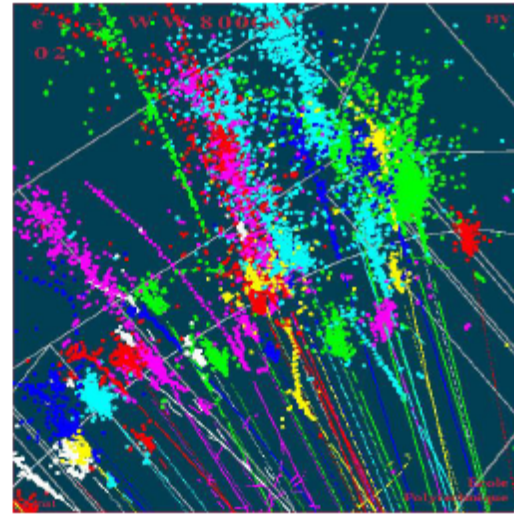

- ★ ILC calorimetric performance = **HARDWARE + SOFTWARE**
- ★ Performance will depend on the software algorithm
- ➡ Nightmare from point of view of detector optimisation
- ★ *a priori* not clear what aspects of **hadronic showers** are important (i.e. need to be well simulated)

M. Thomson

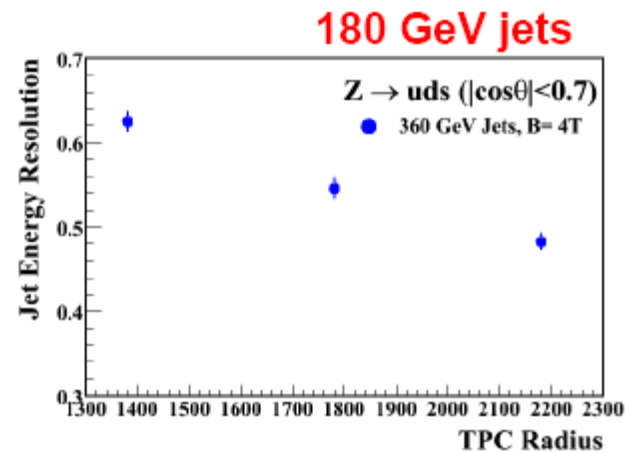
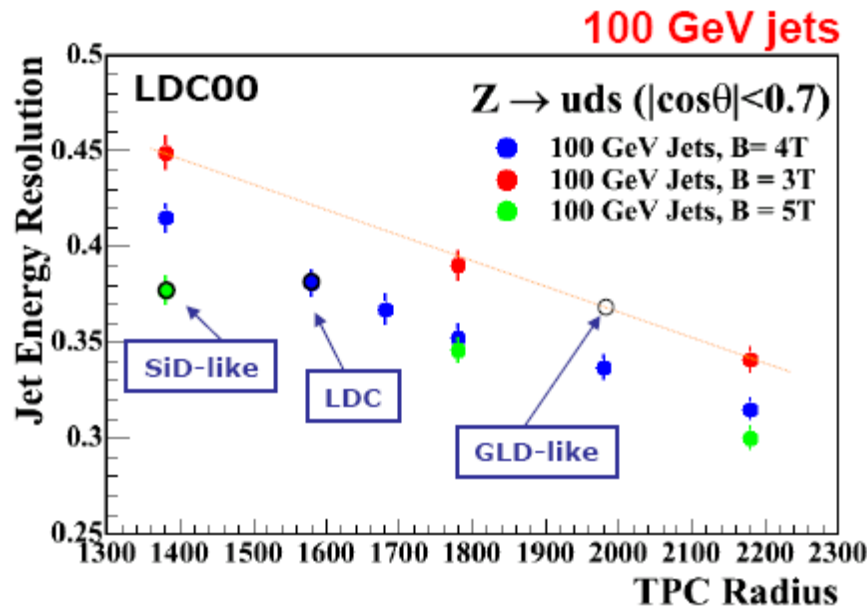
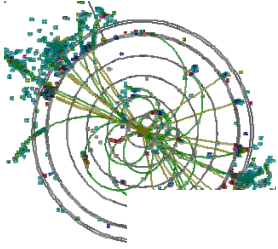

★ Results consistent with:

$$\frac{\sigma_E}{E} \propto \frac{1}{B^{0.24} R^{0.6}}$$

Empirical

- ★ As expected large radius/ large field does best
- ★ But not as strong an effect as might have been expected
- ★ How much due to “intrinsic detector resolution” and how much due to software deficiencies ?

M. Thomson

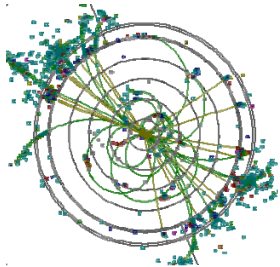

Tracking

- **Tracking for any modern experiment should be conceived as an integrated system, combined optimization of:**
 - ↗ **the inner tracking (vertex detection)**
 - ↗ **the central tracking**
 - ↗ **the forward tracking**
 - ↗ **the integration of the high granularity EM Calorimeter**
- **Pixelated vertex detectors are capable of track reconstruction on their own, as was demonstrated by the 307 Mpixel CCD vertex detector of SLD, and is being planned for the ILC**
- **Track reconstruction in the vertex detector impacts the role of the central and forward tracking system**

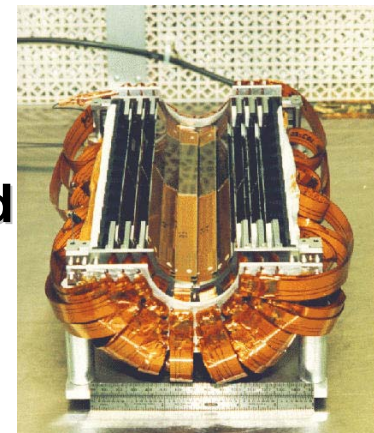

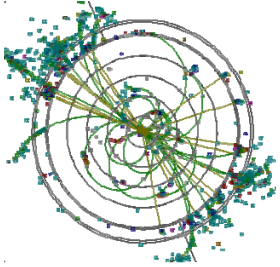

Inner Tracking/Vertex Detection for the ILC

Detector Requirements

- Excellent spacepoint precision (**< 4 microns**)
- Superb impact parameter resolution (**$5\mu\text{m} \oplus 10\mu\text{m}/(p \sin^{3/2}\theta)$**)
- Transparency (**$\sim 0.1\% X_0$ per layer**)
- Track reconstruction (**find tracks in VXD alone**)
- Sensitive to acceptable number of bunch crossings (**$< 150 = 45 \mu\text{sec}$**)
- EMI immunity
- Power Constraint (**< 100 Watts**)

Concepts under Development for International Linear Collider

- Charge-Coupled Devices (CCDs)
 - ↳ demonstrated in large system (307Mpx) at SLD, but slow \Rightarrow Column Parallel CCDs
- Monolithic Active Pixels – CMOS
 - ↳ MAPs, FAPs, Chronopixels, 3D-Fermilab
- DEpleted P-channel Field Effect Transistor (DEPFET)
- Silicon on Insulator (Sol)
- Image Sensor with In-Situ Storage (ISIS)
- HAPS (Hybrid Pixel Sensors)

SiD Vertex Layout

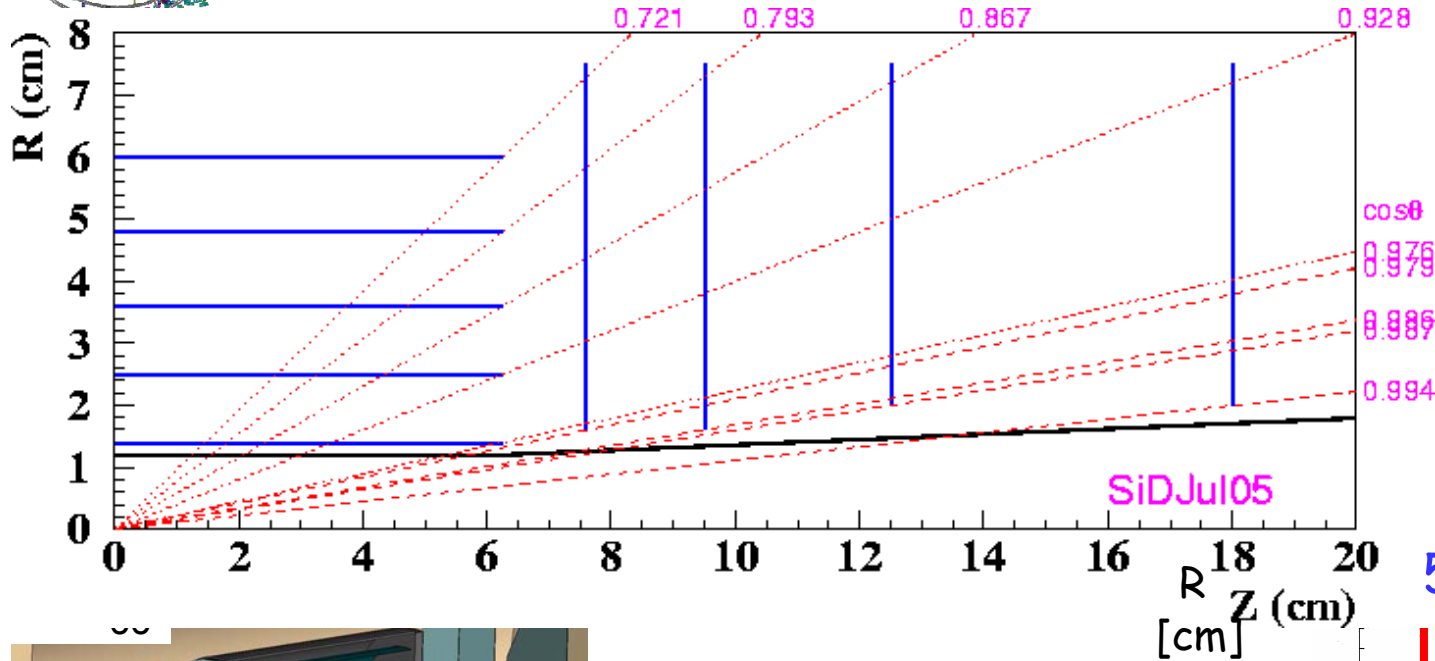
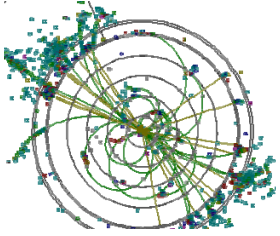

5 barrel layers
4 end disks

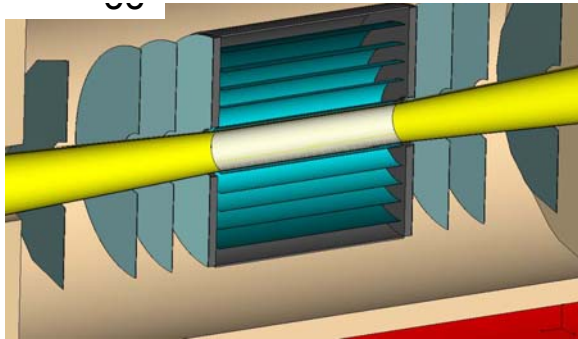

Design drivers:

Smallest radius possible
Clear pair background

Role: Seed tracks & vertexing
Improve forward region

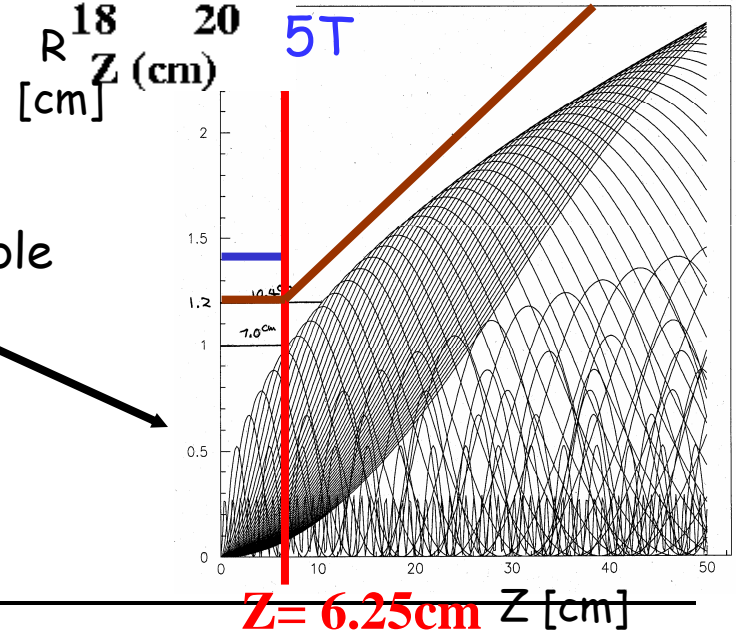

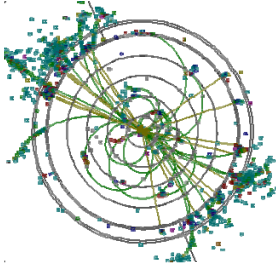

Column Parallel CCD for ILC

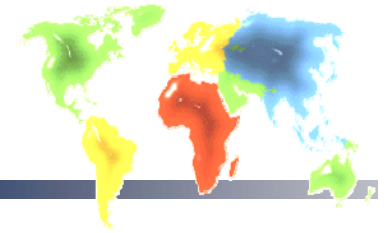

SLD Vertex Detector designed to read out
800 kpixels/channel at 10 MHz, operated at
5 MHz => readout time = 200 msec/ch

ILC requires faster readout for 300 nsec bunch spacing
<< 1 msec

Possible Solution: Column Parallel Readout

LCFI (Bristol,Glasgow,Lancaster,Liverpool,Nijmegen,Oxford,RAL)

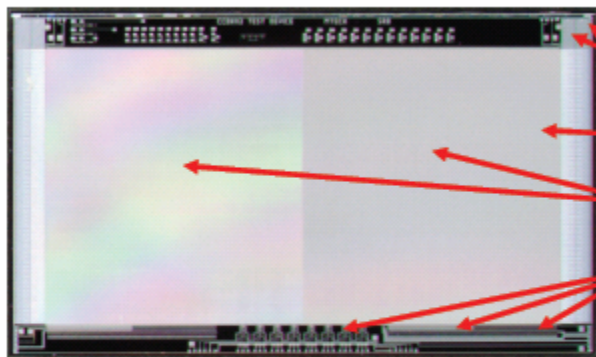

CPC1 produced by E2V

- Two phase operation
- Metal strapping for clock
- 2 different gate shapes
- 3 different types of output
- 2 different implant levels

➤ *Clock with highest frequency at lowest voltage*

- **Separate amplifier and readout for each column**

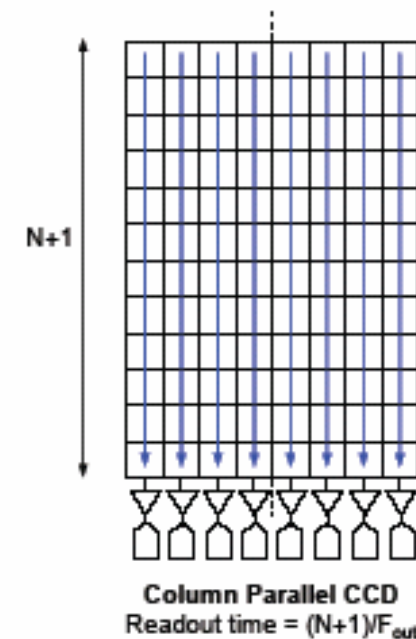

(Whereas SLD used one readout channel for each 400 columns)

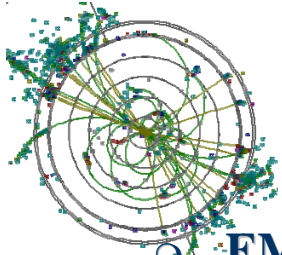
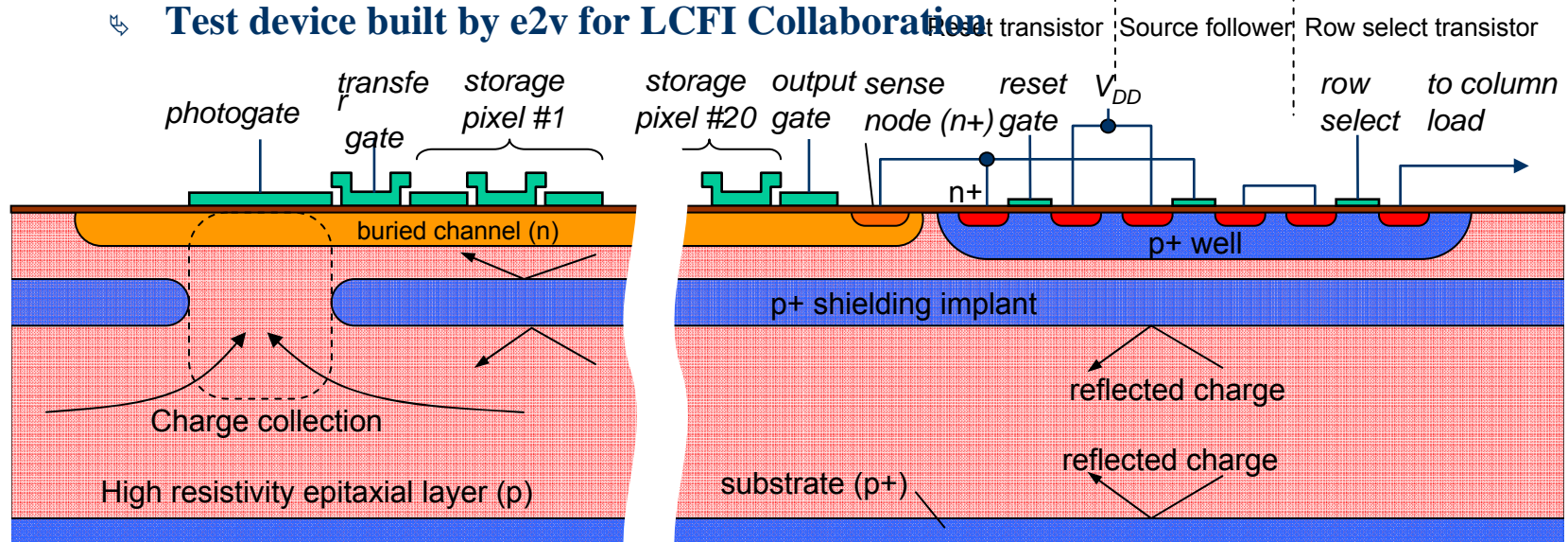
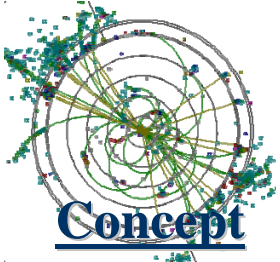

Image Sensor with In-situ Storage (ISIS)



- EMI concern (SLC experience) motivates delayed operation during beam
- Robust storage of charge in buried channel during beam passage
 - ✦ Pioneered by W F Kosonocky et al IEEE SSCC 1996, Digest of Technical Papers, 182
 - ✦ T Goji Etoh et al, IEEE ED 50 (2003) 144; runs up to 1 Mfps.
- ISIS Sensor details:
 - ✦ CCD-like charge storage cells in CMOS or CCD technology
 - ✦ Processed on sensitive epi layer
 - ✦ p+ shielding implant forms reflective barrier (deep implant)
 - ✦ Overlapping poly gates not likely to be available, may not be needed
 - ✦ Test device built by e2v for LCFI Collaboration





Monolithic CMOS for Pixel Detector

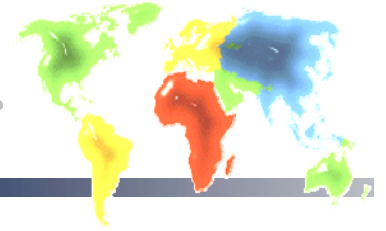

Concept

- Standard VLSI chip, with thin, un-doped silicon sensitive layer, operated undepleted

Advantages

- decoupled charge sensing and signal transfer (improved radiation tolerance, random access, etc.)
- small pitch (high tracking precision)
- Thin, fast readout, moderate price

R&D

- Strasbourg IReS has been working on development of monolithic active pixels since 1989; others (RAL, Yale/Or., etc.)
- IReS prototype arrays of few thousands pixels demonstrated viability.
- Large prototypes now fabricated/tested.
- Attention on readout strategies adapted to specific experimental conditions, and transfer to AMS 0.35 OPTO from TSMC 0.25
 - ↳ ~< 12 um epi vs. < 7 um
- Application to STAR

Parallel R&D:

- FAPS (RAL): 10-20 storage caps/pixel

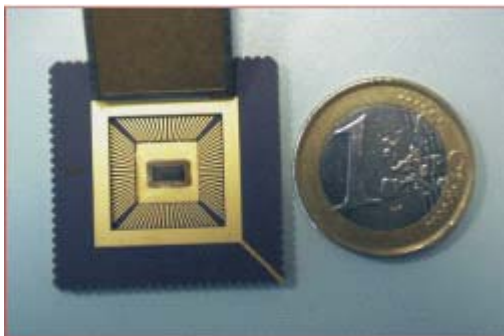

▶▶ MIMOSA VIII

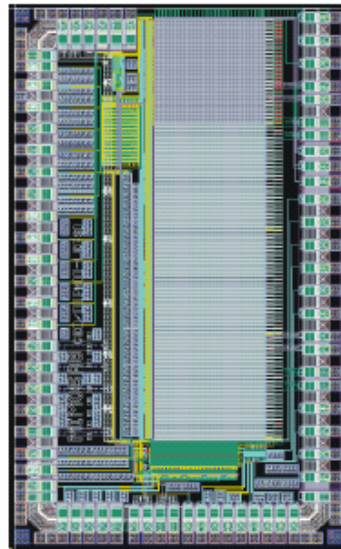

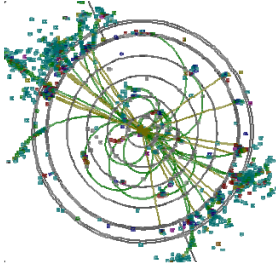

Chronopixel (CMOS)



Yale/Oregon/Sarnoff

- **Completed Macropixel design last year**
 - ⇒ **Key feature – stored hit times (4 deep)**
 - ⇒ **645 transistors**
 - ⇒ **Spice simulation verified design**
 - ⇒ **TSMC 0.18 μm \Rightarrow ~50 μm pixel**
 - ❖ Epi-layer only 7 μm
 - ❖ Talking to JAZZ (15 μm epi-layer)
 - ⇒ **90 nm \Rightarrow 20-25 μm pixel**
- **January, 2007**
 - ⇒ **Completed design - Chronopixel**
 - ⇒ **Deliverable – tape for foundry**
- **Near Future (dependent on funding)**
 - ⇒ **Fab 50 μm Chronopixel array**
 - ❖ Demonstrate performance
 - ⇒ **Then, 10-15 μm pixel**

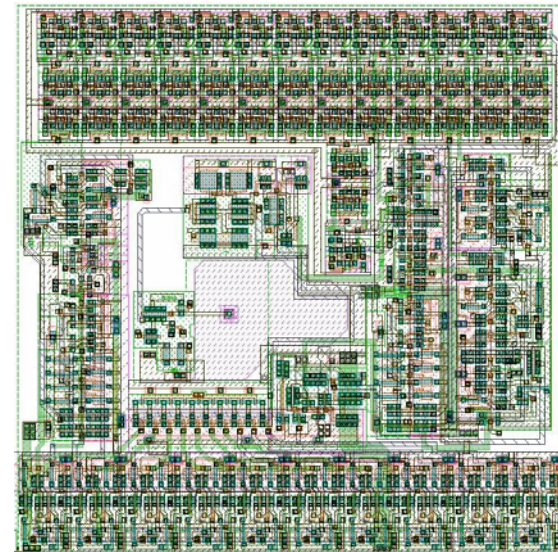
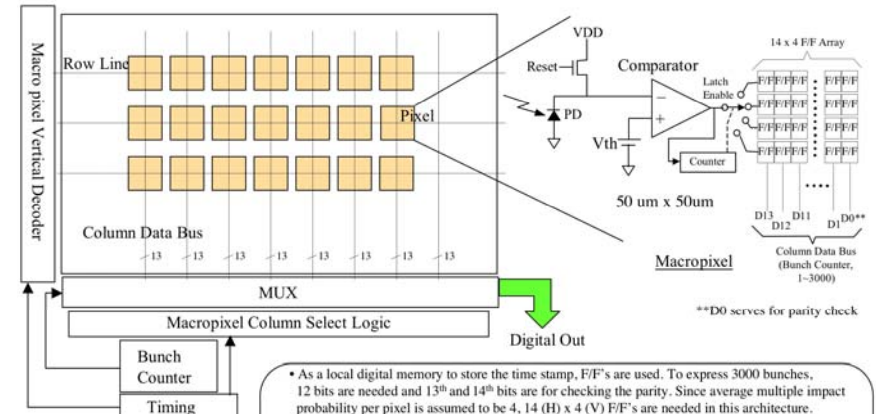

**563
Transistors**

50 μm

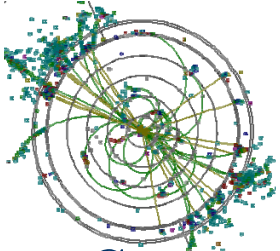

Inner Tracking/Vertex Detection (DEPFET)

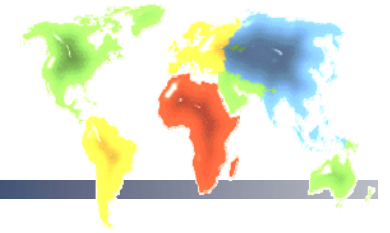

Concept

- Field effect transistor on top of fully depleted bulk
- All charge generated in fully depleted bulk; assembles underneath the transistor channel; steers the transistor current
- Clearing by positive pulse on clear electrode
- **Combined function of sensor and amplifier**

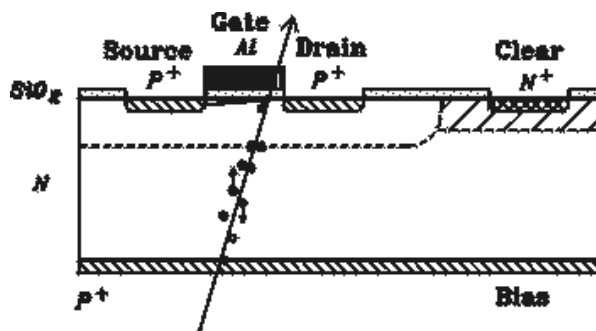

16x128 DEPFET-Matrix

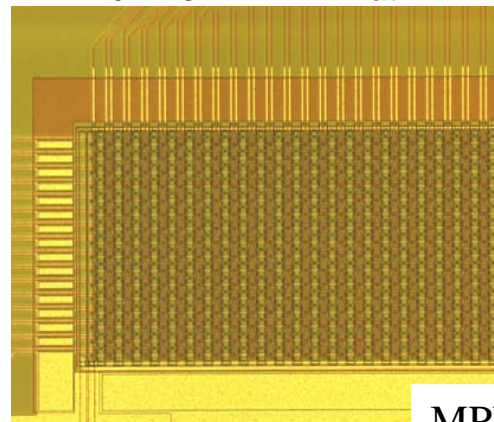

Properties

- low capacitance ► **low noise**
- Signal charge remains undisturbed by readout ► **repeated readout**
- Complete clearing of signal charge ► **no reset noise**
- Full sensitivity over whole bulk ► **large signal for m.i.p.; X-ray sens.**
- Thin radiation entrance window on backside ► **X-ray sensitivity**
- Charge collection also in turned off mode ► **low power consumption**
- Measurement at place of generation ► **no charge transfer (loss)**
- Operation over very large temperature range ► **no cooling needed**

MPI Munich, MPI Halle, U. Bonn, U. Mannheim

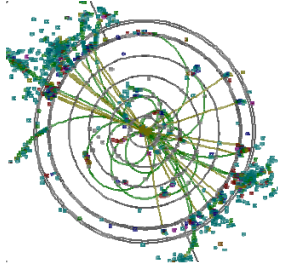

Central Tracking

- **Two general approaches being developed for the ILC**
 - TPC (GLD, LDC, 4th)**
 - Builds on successful experience of PEP-4, ALEPH, ALICE, DELPHI, STAR,
 - Large number of space points, making reconstruction straightforward
 - $dE/dx \Rightarrow$ particle ID, bonus
 - Minimal material, valuable for calorimetry
 - Tracking up to large radii
 - Silicon (SiD)**
 - Superb spacepoint precision allows tracking measurement goals to be achieved in a compact tracking volume
 - Robust to spurious, intermittent backgrounds
 - ILC is not a storage ring

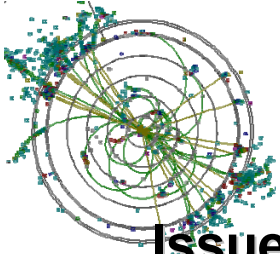

Central Tracking with TPC

Issues for an ILC TPC

- **Optimize novel gas amplification systems**
 - ↗ **Conventional TPC readout based on MWPC and pads**
 - ❖ limited by positive ion feedback and MWPC response
 - ↗ **Improvement by replacing MWPC readout with micropattern gas chambers (eg. GEMs, Micromegas, Medipix)**
 - ❖ Small structures (no $E \times B$ effects)
 - ❖ 2-D structures
 - ❖ Only fast electron signal
 - ❖ Intrinsic ion feedback suppression
- **Neutron and gamma backgrounds (~130 bunch crossings)**
- **Optimize single point and double track resolution**
- **Performance in high magnetic fields**
- **Demonstrate large system performance with control of systematics**
- **Minimize impact of endplate**

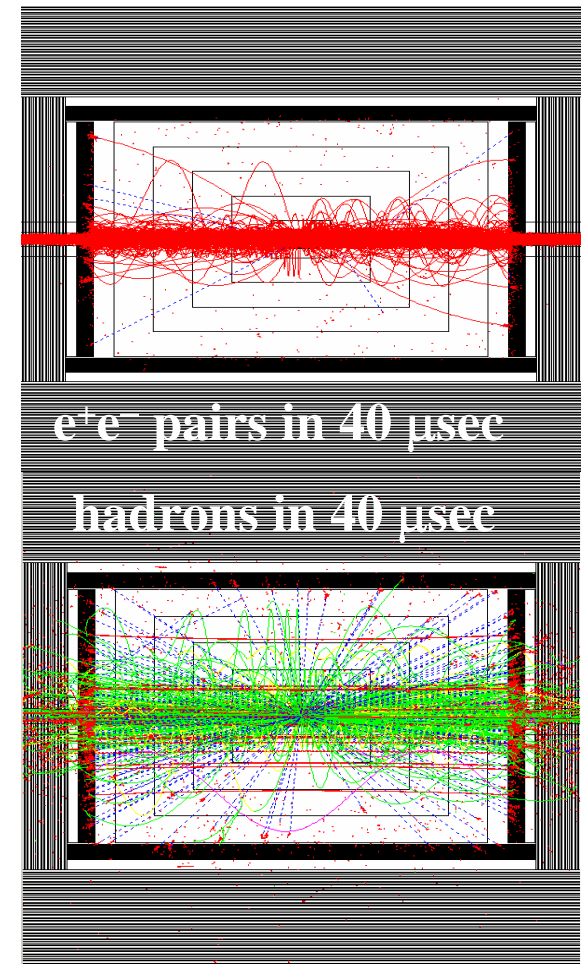

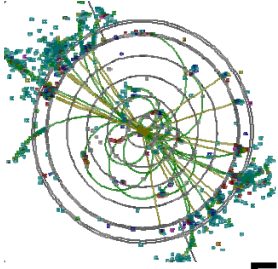

Central Tracking with Silicon

Expecting the machine backgrounds (esp. beam loss occurrences) of the ILC to be erratic (based on SLC experience),
robustness of silicon is very attractive.
single bunch timing

The SiD barrel tracking is baselined as 5 layers of pixellated vertex detector and 5 layers of Si strip detectors (in ~10 cm segments) going out to 1.25 meters

With superb position resolution, compact tracker which achieves the linear collider tracking resolution goals is possible

Compact tracker makes the calorimeter smaller and therefore cheaper, permitting more aggressive technical choices (assuming cost constraint)

Silicon tracking layer thickness determines low momentum performance

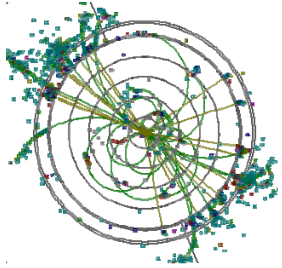

SID₀₀

Tracking

- Closed CF/Rohacell cylinders
- Nested support via annular rings
- Power/readout motherboard mounted on support rings

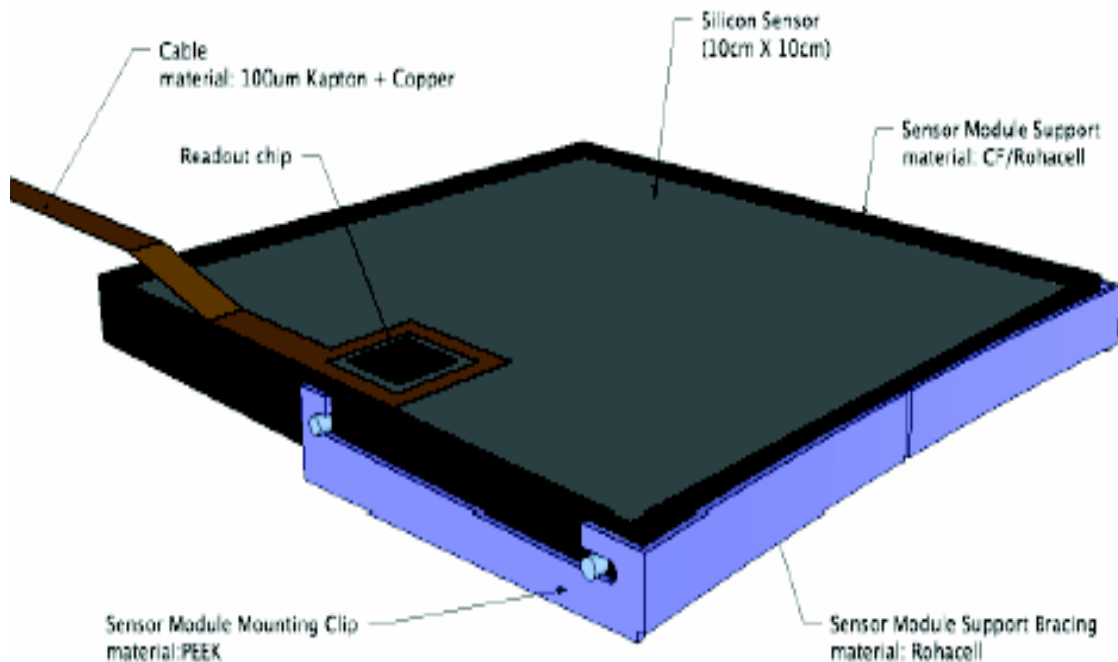
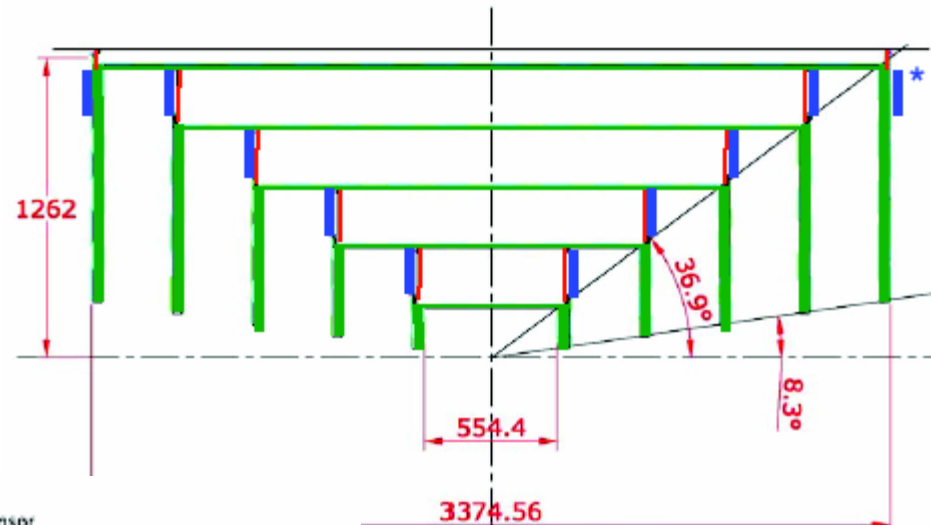

- Cylinders tiled with 10x10cm sensors with readout chip
- Single sided (ϕ) in barrel
- R, ϕ in disks
- Modules mainly silicon with minimal support (0.8% X_0)
- Overlap in ϕ and z

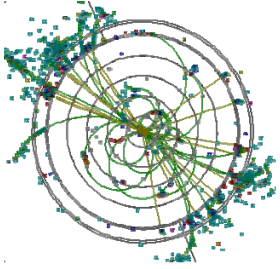

Material Budget of Silicon Tracker

~ 0.8 %/layer at normal incidence

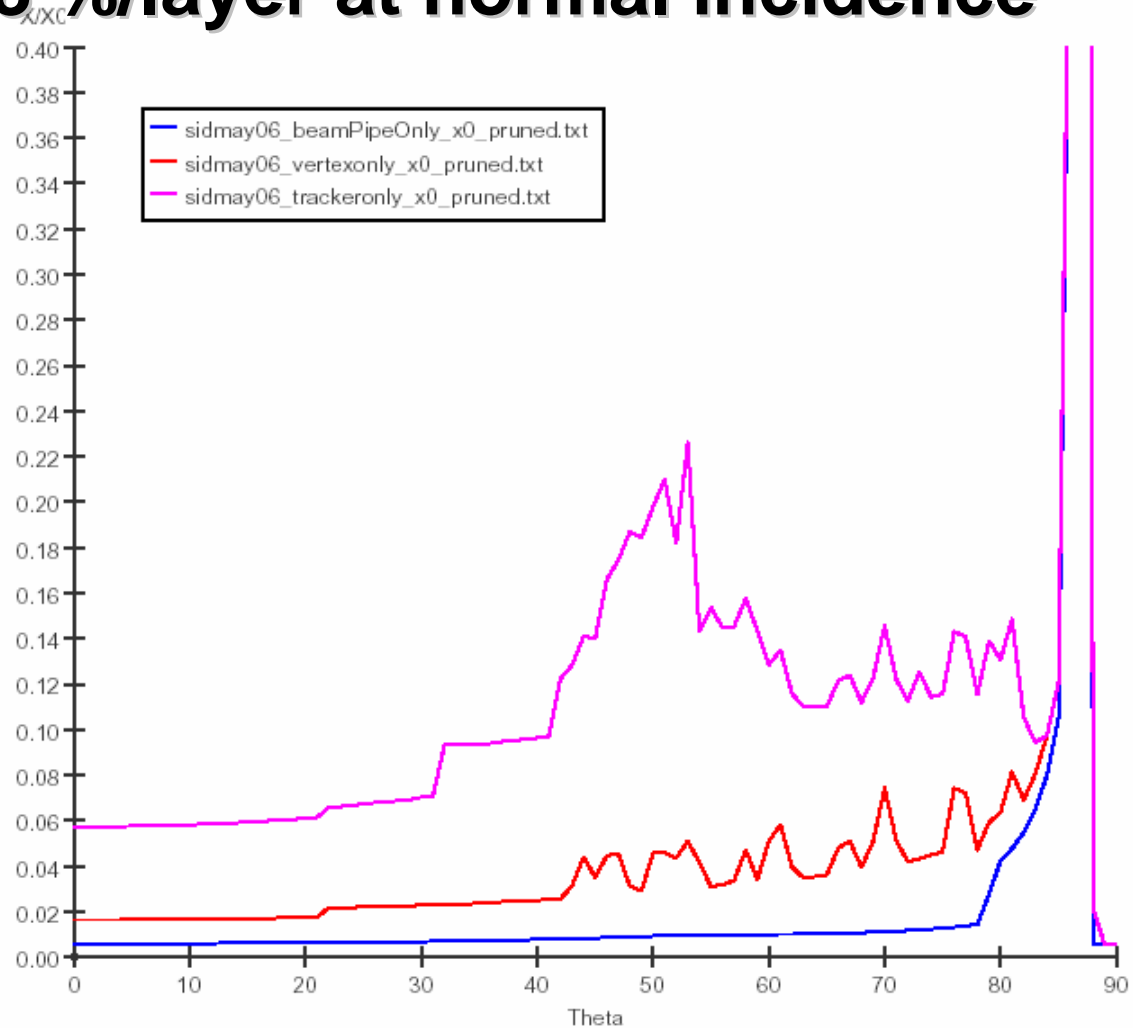

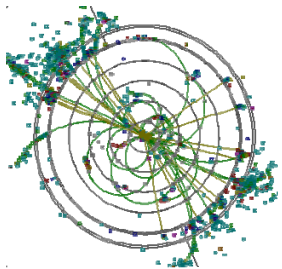

Robust Pattern Recognition with Silicon

- **t tbar event in VXD**

w/ backgrounds from 150 bunch crossings
- BUT 1 billion pixels!

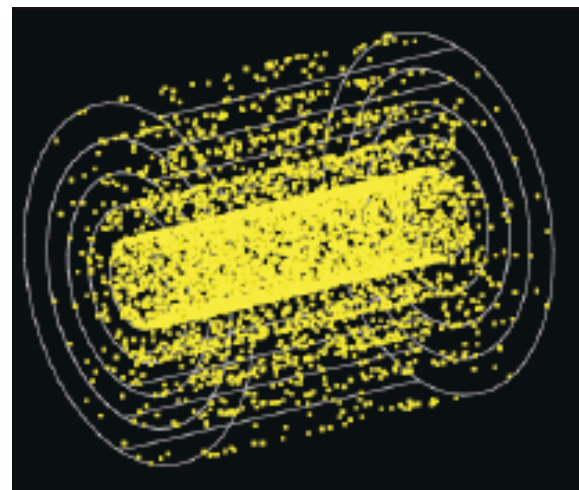
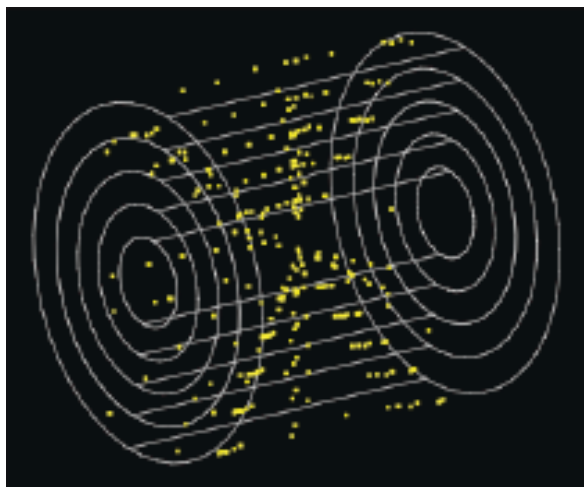

**clean detection with
time stamping**

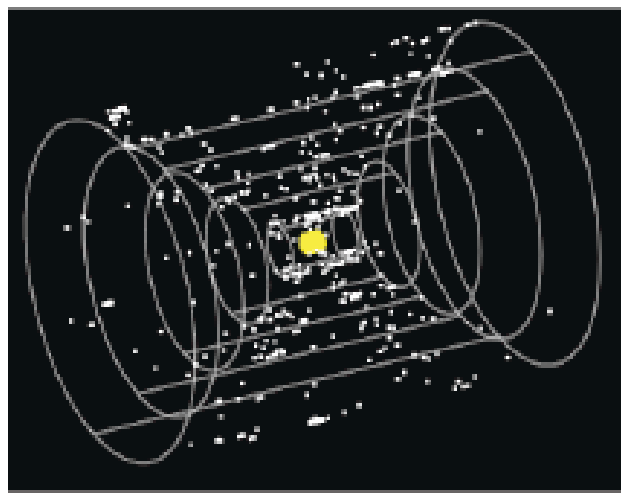

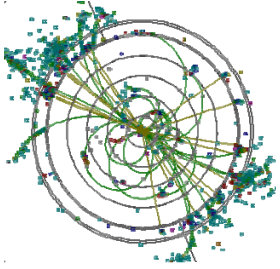

Excellent momentum resolution with Silicon

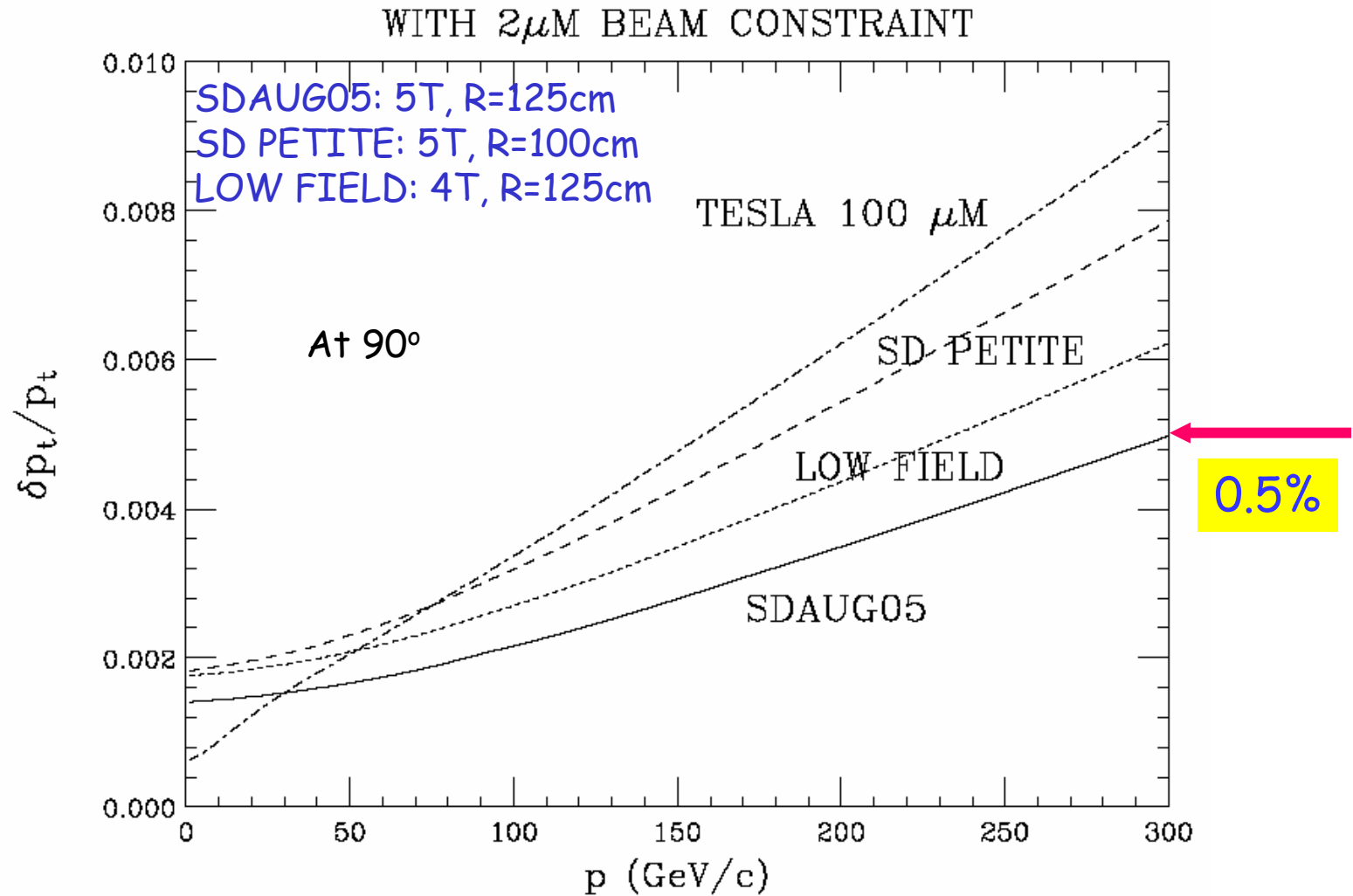

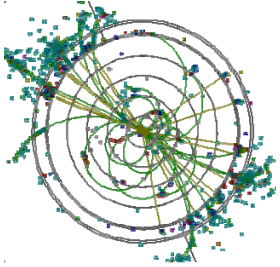

Other Efforts

- **High Field Solenoid**
- **Outer Muon Detector**
 - ↪ Requirements, Technology
- **Machine Detector Interface**
 - ↪ Tight coupling to Collider
- **Very Forward Instrumentation**
 - ↪ 10 MGy/year in most forward elements
 - ↪ Luminosity measurements
- **Beamline Instrumentation**
 - ↪ Energy, Luminosity, Polarization

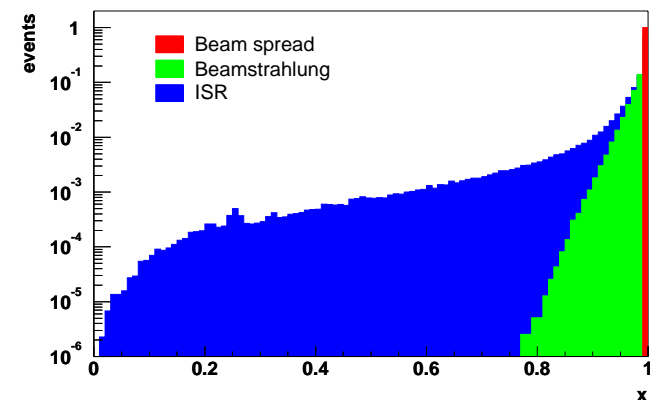

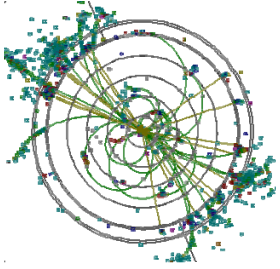

The GDE Plan and Schedule

2005 2006 2007 2008 2009 2010

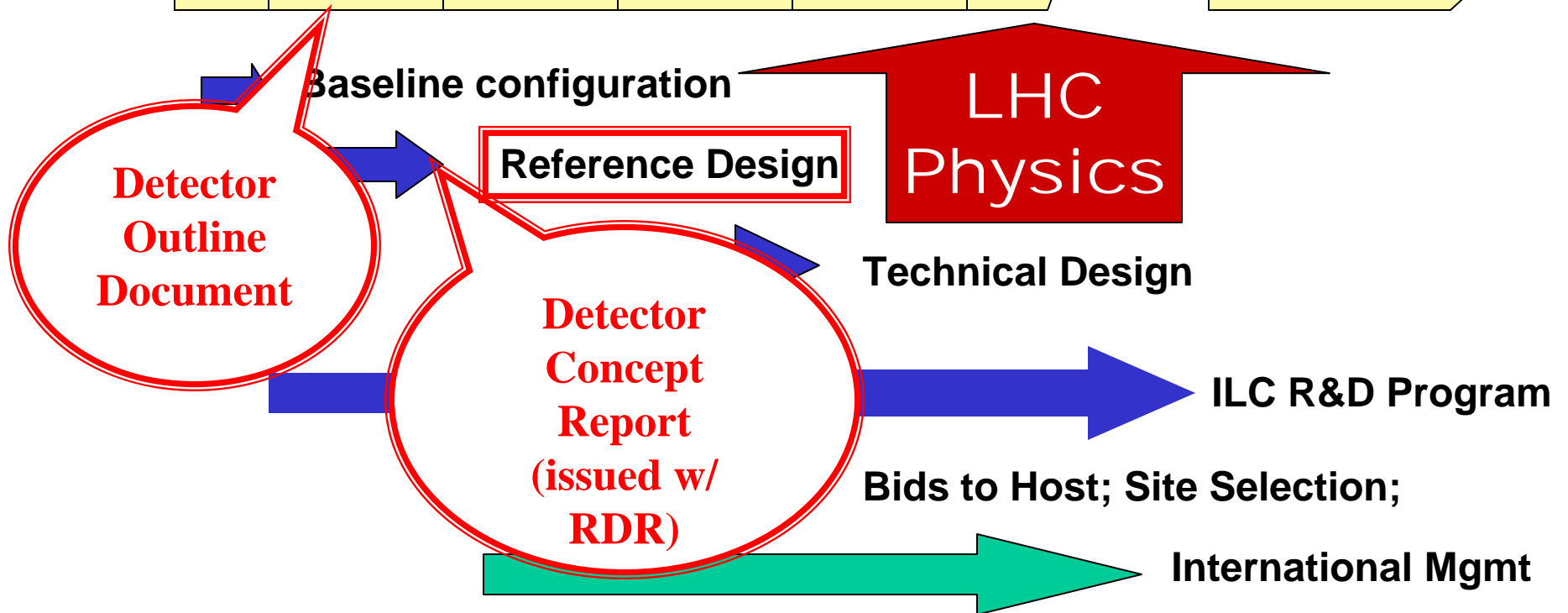

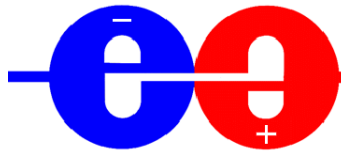

Worldwide Study of
the Physics and Detectors

for Future Linear
e⁺e⁻ Colliders

Detector Roadmap (the future)

DETECTOR ROADMAP PROPOSAL **UNDER DISCUSSION (not yet implemented)**

- 2008 – Conceptual Design Reports received by Intl Det Adv Gp
Panel characterizes positive aspects and criticizes weaknesses
Guides community to the definition of two detectors for
EDR preparation
Collaborations formed to develop EDRs
- 2009-2011 – Development of two technical designs,
produce first technical design report for the overall detectors,
which will be followed by additional volumes
(detailed technical reports on subsystems)

Presented by WWS at ILCSC meeting in Valencia, Nov 11, 2006
Will be taken up again in Beijing at ILCSC meeting in February

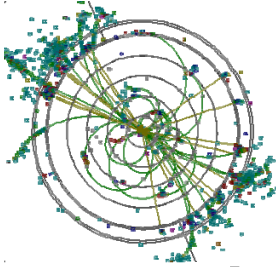

Concluding Remarks

- **ILC Detector R&D**

DISCOVERY OPPORTUNITIES at the ILC will be limited by detector performance

advances different from LHC required

program of ILC Detector R&D has been underway for years
particularly strong in Europe

**Challenges are defined
Teams are prepared
Funding has limited
progress, so far**

